

Pressure Independent Valve, 2-way, Internal thread, (EPIV)

- Nominal voltage AC/DC 24 V
- Control Modulating, Communicative, Hybrid

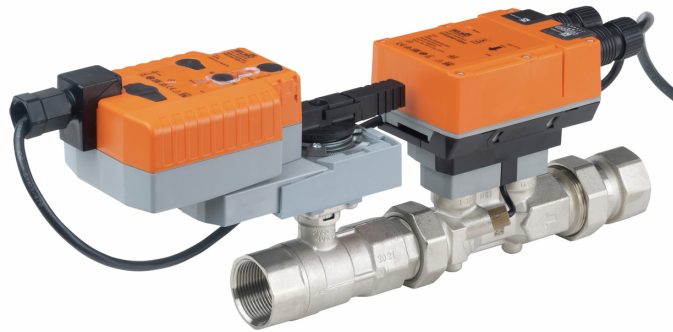

5-year warranty



### Type Overview

<b>Type</b>	<b>DN</b>
EP200H+AKRX-E	2" [50]

### Technical data

<b>Electrical data</b>	Nominal voltage	AC/DC 24 V	
	Nominal voltage frequency	50/60 Hz	
	Nominal voltage range	AC 19.2...28.8 V / DC 21.6...28.8 V	
	Power consumption in operation	6 W	
	Power consumption in rest position	5 W	
	Transformer sizing	12 VA	
	Connection supply/control	cable 3 ft. [1 m], 6 x 0.75 mm <sup>2</sup>	
	Conductors, cables	Power supply AC/DC 24 V: cable length <100 m	
	Cable length	3 ft [1 m]	
	Electrical Connection	18 AWG plenum cable	
<b>Data bus communication</b>	Communicative control	BACnet MS/TP Modbus RTU MP-Bus	
	<b>Functional data</b>	Valve size [mm]	2" [50]
		Operating range Y	2...10 V
Operating range Y variable		0.5...10 V	
Operating range Y note		4...20 mA w/ ZG-R01 (500 Ω, 1/4 W resistor)	
Input impedance		100 kΩ (0.1 mA), 500 Ω	
Operating modes optional		VDC variable	
Position feedback U		2...10 V	
Position feedback U note		Max. 1 mA	
Position feedback U variable		VDC variable	
Setting fail-safe position		NC/NO or adjustable 0...100% (POP rotary knob)	
Bridging time (PF) variable		0...10 s	
Running Time (Motor)		90 s	
Running time fail-safe		<35 s	
Noise level motor		45 dB(A) dB(A)	
Noise level, fail-safe		61 dB(A)	
V'max adjustable	25...100% of V'nom		
Control accuracy	±5% (of 25...100% V'nom)		

**Technical data**

<b>Functional data</b>	Min. controllable flow	1% of V'nom
	Configuration	via NFC, Belimo Assistant 2
	Fluid	chilled or hot water, up to 60% glycol max (open loop/steam not allowed)
	Fluid temperature	14...250°F [-10...120°C]
	Close-off pressure Δps	200 psi
	Differential pressure note	8...50 psi
	Flow characteristic	equal percentage or linear
	Body Pressure Rating	360 psi
	Leakage rate	0% leakage
	GPM	100
	Pipe connection	Internal thread NPT (female)
	Installation orientation	upright to horizontal (in relation to the spindle)
	Servicing	maintenance-free
	Manual override	external push button
	Inlet Length to Meet Specified Measurement Accuracy	≥ to 0 x DN (according to EN1434-4:2022)
<b>Measuring data</b>	Measured values	Flow
	Temperature sensor	Pt1000 - EN 60751, 2-wire technology, inseparably connected integrated in flow sensor
<b>Temperature measurement</b>	Measuring accuracy absolute temperature	32.6°F @ 50°F [± 0.35°C @ 10°C] (Pt1000 EN60751 Class B) 33°F @ 140°F [± 0.6°C @ 60°C] (Pt1000 EN60751 Class B)
<b>Flow measurement</b>	Measuring principle	Ultrasonic flow measurement
	Measuring accuracy flow	±2%
	Min. flow measurement	0.5% of V'nom
	Measurement repeatability	±0.5% (Flow)
	Sensor technology	Ultrasonic with glycol and temperature compensation
<b>Safety data</b>	Degree of protection NEMA/UL	NEMA 2
	Housing	UL Enclosure Type 2
	Pressure equipment directive	CE according to 2014/68/EU
	Quality Standard	ISO 9001
	UL 2043 Compliant	Suitable for use in air plenums per Section 300.22(C) of the NEC and Section 602 of the IMC
	Rated impulse voltage supply / control	0.8 kV
	Ambient humidity	Max. 100% RH
	Ambient temperature	-22...122°F [-30...50°C]
	Storage temperature	-40...176°F [-40...80°C]
<b>Materials</b>	Valve body	Forged brass, nickel-plated
	Body finish	nickel-plated
	Flow measuring pipe	Forged brass, nickel-plated
	Valve plug	Stainless steel
	Stem	stainless steel
	Stem seal	EPDM (lubricated)
	Seat	PTFE

Technical data

<b>Materials</b>	Characterized disc	TEFZEL®
	O-ring	EPDM
	Ball	stainless steel
<b>Terms</b>	Abbreviations	POP = Power off position / fail-safe position PF = Power fail delay time / bridging time

Safety notes



- This device has been designed for use in stationary heating, ventilation and air-conditioning systems and must not be used outside the specified field of application, especially in aircraft or in any other airborne means of transport.
- Outdoor application: only possible in case that no (sea) water, snow, ice, insolation or aggressive gases interfere directly with the actuator and that is ensured that the ambient conditions remain at any time within the thresholds according to the data sheet.
- Only authorized specialists may carry out installation. All applicable legal or institutional installation regulations must be complied with during installation.
- The device contains electrical and electronic components and must not be disposed of as household refuse. All locally valid regulations and requirements must be observed.

Product features

**Operating mode** The HVAC performance device is comprised of three components: characterized control valve (CCV), measuring pipe with flow sensor and the actuator itself. The adjusted maximum flow ( $V'_{max}$ ) is assigned to the maximum control signal (typically 100%). The HVAC performance device can be controlled via communicative signals. The fluid is detected by the sensor in the measuring pipe and is applied as the flow value. The measured value is balanced with the setpoint. The actuator corrects the deviation by changing the valve position. The angle of rotation  $\alpha$  varies according to the differential pressure through the control element (see flow curves).

With the supply voltage, the integrated capacitors will be charged.

Interrupting the supply voltage causes the valve to be moved to the selected fail-safe position by means of stored electrical energy.

**Flow measurement** All flow tolerances are at 68°F [20°C] & water.

Flow rate curves

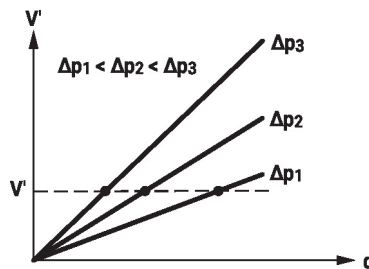

**Product features**

**Pre-charging time (start up)**

The capacitor actuators require a pre-charging time. This time is used for charging the capacitors up to a usable voltage level. This ensures that, in the event of a power failure, the actuator can move at any time from its current position into the preset fail-safe position.

The duration of the pre-charging time depends mainly on following factors:

- Duration of the power failure
- PF delay time (bridging time)

Typical pre-charging time

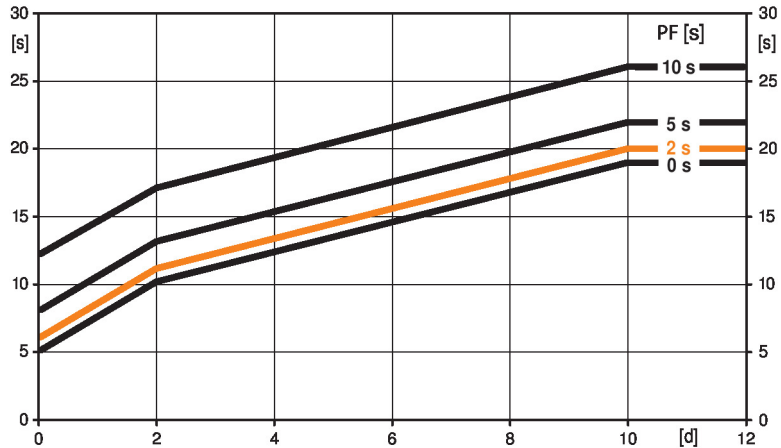

[d] = Power failure in days  
 [s] = Pre-charging time in seconds  
 PF[s] = Bridging time

Calculation example: Given a power failure of 3 days and a bridging time (PF) set at 5 s, the actuator requires a pre-charging time of 14 s after the power has been reconnected (see graphic).

PF [s]	[d]				
	0	1	2	7	≥10
0	5	8	10	15	19
2	6	9	11	16	20
5	8	11	13	18	22
10	12	15	17	22	26
[s]					

**Delivery condition (capacitors)**

The actuator is completely discharged after delivery from the factory, which is why the actuator requires approximately 20 s pre-charging time before initial commissioning in order to bring the capacitors up to the required voltage level.

**Bridging time**

Power failures can be bridged up to a maximum of 10 s.

In the event of a power failure, the actuator will remain stationary in accordance with the set bridging time. If the power failure is greater than the set bridging time, the actuator will move into the selected fail-safe position.

The bridging time set at the factory is 2 s. It can be modified on site in operation by means of the Belimo service tool MFT-P.

Settings: The rotary knob must not be set to the "PROG FAIL-SAFE" position!

For retroactive adjustments of the bridging time with the Belimo service tool MFT-P or with the ZTH EU adjustment and diagnostic device only the values need to be entered.

**Setting fail-safe position**

The rotary knob fail-safe position can be used to adjust the desired fail-safe position 0...100% in 10% increments. The rotary knob always refers to the adapted angle-of-rotation range. In the event of a power failure, the actuator will move into the selected fail-safe position.

Settings: The rotary knob must be set to the «Tool» position for retroactive settings of the fail-safe position with the Belimo service tool MFT-P. Once the rotary knob is set back to the range 0...100%, the manually set value will have positioning authority.

Product features

**Control characteristics** The fluid velocity is measured in the measuring component (sensor electronics) and converted to a flow rate signal.

The control signal Y corresponds to the power Q via the exchanger, the volumetric flow is regulated in the EPIV. The control signal Y is converted into a linear characteristic curve and provided with the V'max value as the new reference variable w. The momentary control deviation forms the control signal Y1 for the actuator.

The specially configured control parameters in connection with the precise flow rate sensor ensure a stable quality of control. They are however not suitable for rapid control processes, i.e. for domestic water control. U5 displays the measured flow as voltage (factory setting).

Parametrizing V'max with ZTH:

U5 refers to the respective V'nom, i.e. if V'max is e.g. 50% of V'nom, then Y = 10 V, U5 = 5 V.

Parametrizing V'max with PC-Tool:

In the PC-Tool, the maximum flow rate to which U5 refers can be set individually. If V'max is changed (e.g. to 70% V'nom), the U5 flow range is also automatically changed to the same value (e.g. 70% V'nom: U5 = 10 V). This adjustment can be reversed by entering a value manually (U5 flow range = 100%: U5 refers to V'nom).

As an alternative, U5 can be used for displaying the valve opening angle.

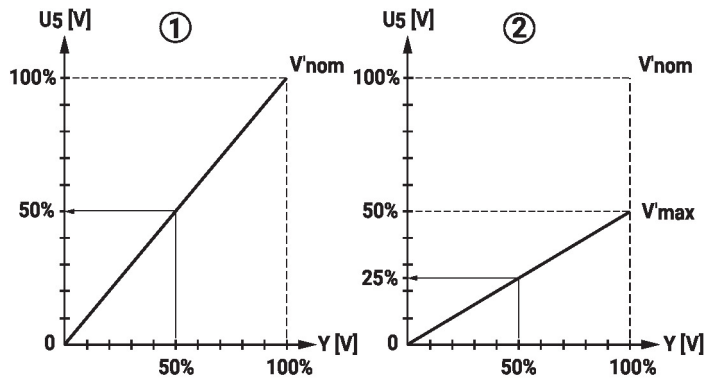

Block diagram

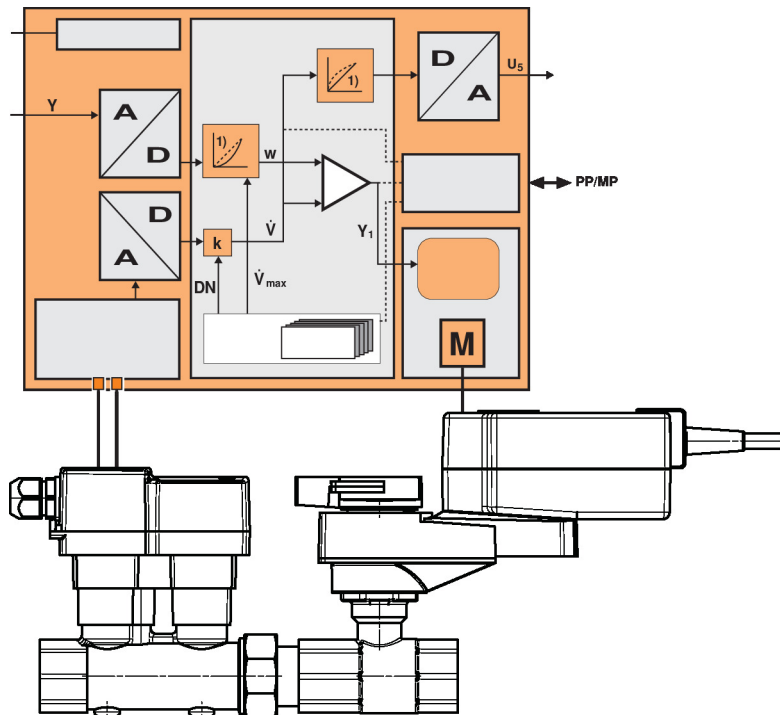

## Product features

## Flow control

$V_{nom}$  is the maximum possible flow.

$V_{max}$  is the maximum flow rate which has been set with the highest control signal DDC.

$V_{max}$  can be set between 25% and 100% of  $V_{nom}$ .

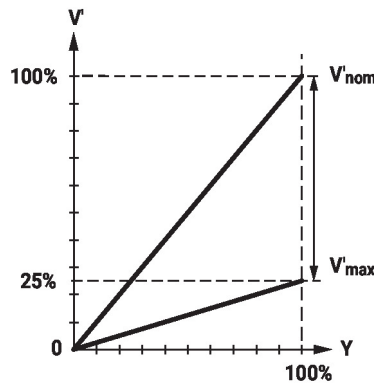
**Fluid temperature measurement**

The integrated temperature sensor within the flow sensor continuously measures the medium's temperature. This measured value can be accessed through the bus system or via the analog feedback signal U. Additionally, the current temperature reading is displayed in the Belimo Assistant 2 App.

**Creep flow suppression**

Given the very low flow speed in the opening point, this can no longer be measured by the sensor within the required tolerance. This range is overridden electronically.

## Opening valve

The valve remains closed until the flow required by the control signal DDC corresponds to 1% of  $V_{nom}$ . The control along the flow characteristic is active after this value has been exceeded.

## Closing valve

The control along the flow characteristic is active up to the required flow rate of 1% of  $V_{nom}$ . Once the level falls below this value, the flow rate is maintained at 1% of  $V_{nom}$ . If the level falls below the flow rate of 0.5% of  $V_{nom}$  required by the control signal DDC, then the valve will close.

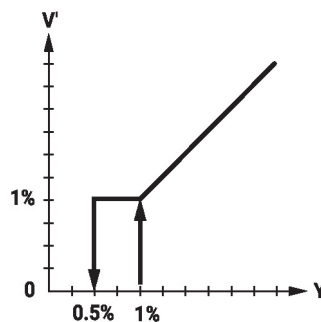
**Converter for sensors**

Connection option for a sensor (active or with switching contact). In this way, the analog sensor signal can be easily digitized and transferred to the bus systems BACnet, Modbus or MP-Bus.

**Control signal inversion**

This can be inverted in cases of control with an analog control signal. The inversion causes the reversal of the standard behavior, i.e. at a control signal of 0%, is equal to  $V_{max}$ , and the valve is closed at a control signal of 100%.

**Hydronic balancing**

With the Belimo tools, the maximum flow rate (equivalent to 100% requirement) can be adjusted on-site, simply and reliably, in a few steps. If the device is integrated in the management system, then the balancing can be handled directly by the management system.

**Combination analogue - communicative (hybrid mode)**

With conventional control by means of an analog control signal DDC, BACnet, Modbus, or MP-Bus can be used for the communicative position feedback.

**Product features**

**Manual override** Manual control with push-button possible - temporary. The gear train is disengaged and the actuator decoupled for as long as the button is pressed.

**Accessories**

Tools	Description	Type
	Belimo Assistant Link Bluetooth and USB to NFC and MP-Bus converter for configurable and communicative devices	LINK.10

**Electrical installation**



Supply from isolating transformer.

The wiring of the line for BACnet MS/TP / Modbus RTU is to be carried out in accordance with applicable RS485 regulations.

Modbus / BACnet: Supply and communication are not a galvanic dry contact. COM and the ground of the devices must be connected.

Analogue output: An analogue output (wire 5) is available on the flow sensor. It can be selected as 0...10 V, 0.5...10 V, 2...10 V or user defined. For example, the flow rate or the temperature of the temperature sensor (Pt1000 - EN 60751, 2-wire technology) can be output as an analogue value.

**Wire colors:**

- 1 = black
- 2 = red
- 3 = white
- 5 = orange
- 6 = pink
- 7 = grey

**Functions:**

- C1 = D- (wire 6)
- C2 = D+ (wire 7)

AC/DC 24 V, modulating

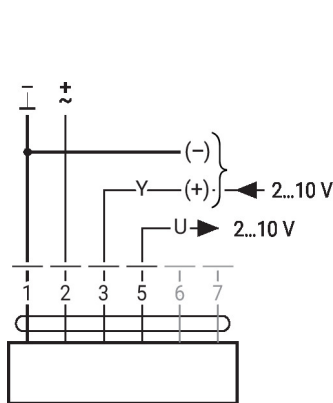

Modbus RTU / BACnet MS/TP with analog setpoint (hybrid operation)

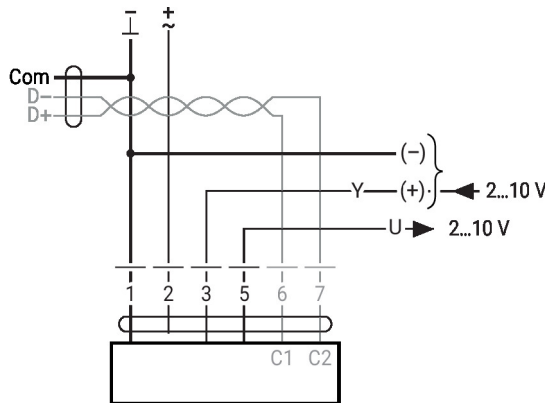

BACnet MS/TP / Modbus RTU

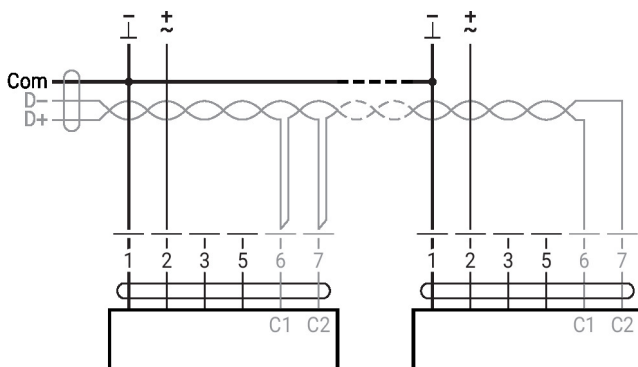

MP-Bus

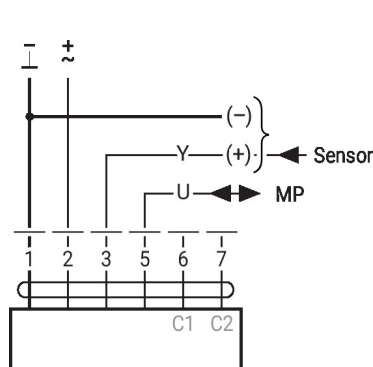

**Electrical installation**

**Converter for sensors**

Connection with switching contact, e.g., differential pressure switch

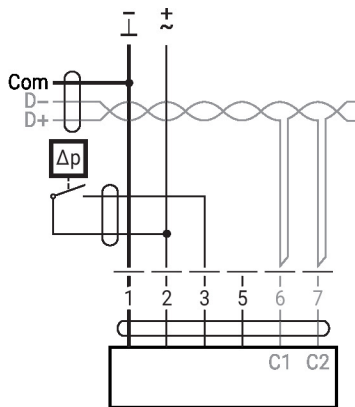

Switching contact requirements:  
The switching contact must be able to switch a current of 16 mA at 24 V accurately.

Connection with active sensor, e.g. 0...10 V @ 0...50°C

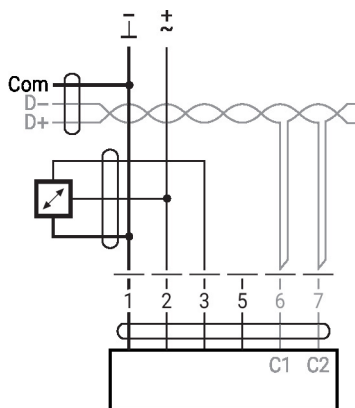

Possible voltage range: 0...32 V  
Resolution 30 mV

**Further electrical installations**

**Functions with specific parameters (configuration necessary)**

Override control and limiting with AC 24 V with relay contacts (with conventional control or hybrid mode)

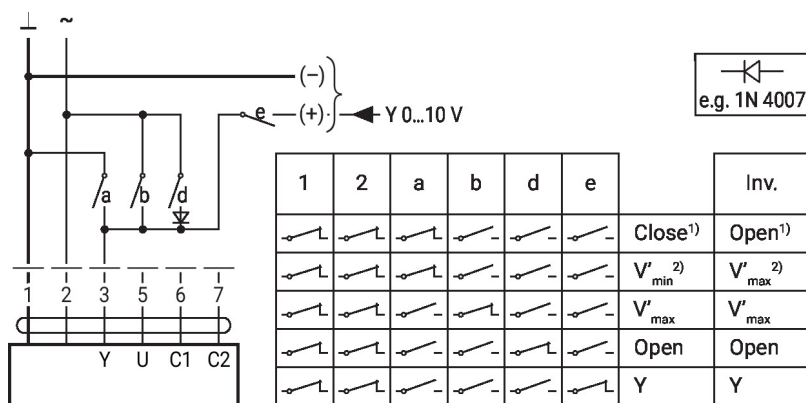

1) Position control  
2) Flow control  
Inv. = control signal inverted

**Further electrical installations**

**Functions with specific parameters (configuration necessary)**

Override control and limiting with DC 24 V with relay contacts (with conventional control or hybrid mode)

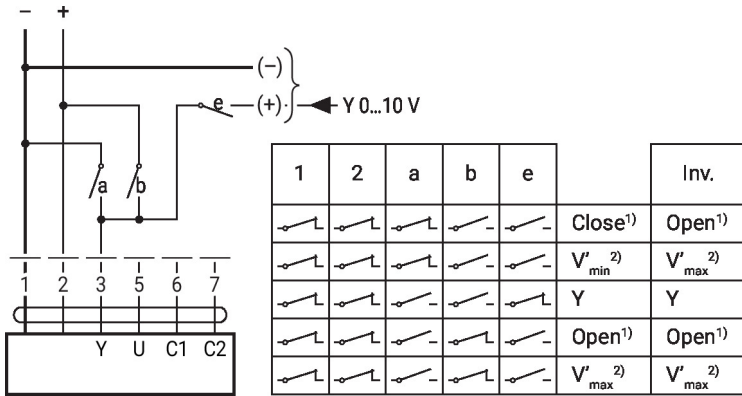

1) Position control  
2) Flow control  
Inv. = control signal inverted

**Control 3-point with AC 24 V**

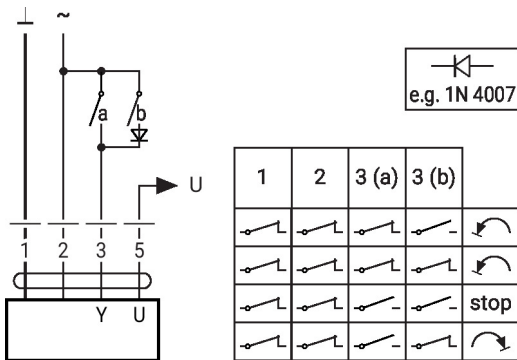

Position control: 90° = 100 s  
Flow control: V'max = 100 s

**BACnet MS/TP / Modbus RTU with analogue setpoint (hybrid mode)**

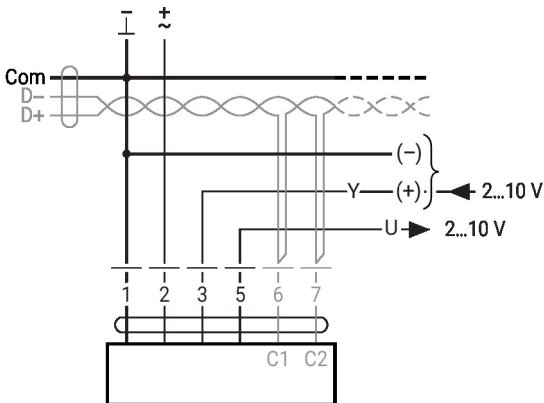

**MP-Bus, supply via 3-wire connection**

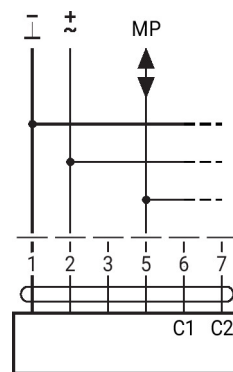

**MP-Bus via 2-wire connection, local power supply**

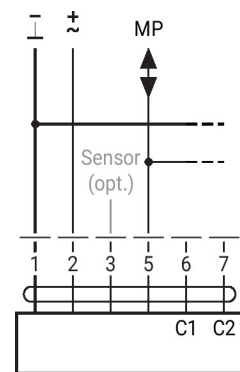

Operating controls and indicators

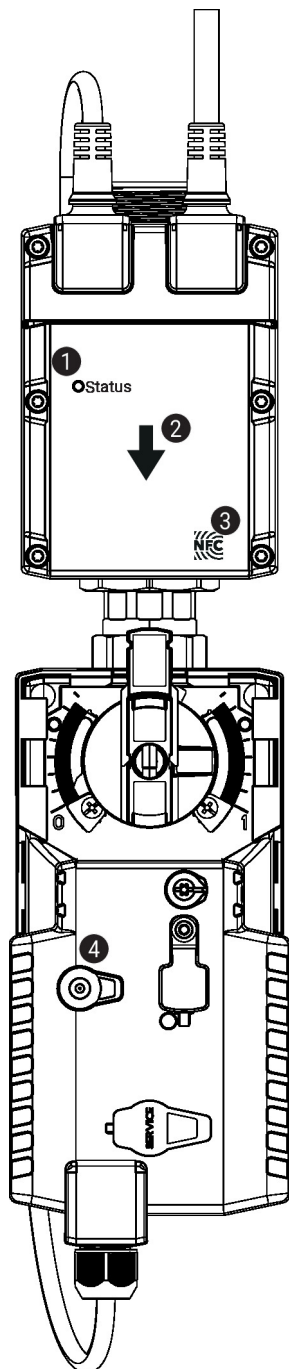

**1 LED display green**

- On: Device starting up
- Off: No power supply or wiring error
- Flashing: In operation (voltage ok)

**2 Flow direction**

**3 NFC interface**

**4 Manual override button**

- Press button: Gear train disengages, motor stops, manual override possible
- Release button: Gear train engages, standard mode. Device performs synchronization.

Operating controls and indicators

Setting fail-safe position

Setting fail-safe position (POP)

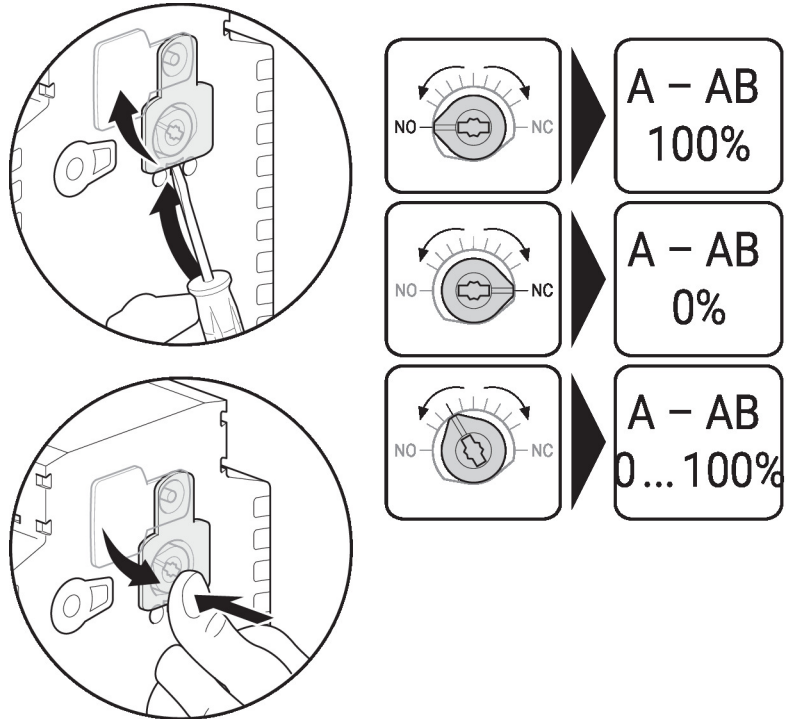

Installation notes

**Permissible installation orientation** The ball valve can be installed upright to horizontal. The ball valve may not be installed in a hanging position, i.e. with the stem pointing downwards.



**Installation location in return** Installation in the return is recommended.

**Water quality requirements** The water quality requirements specified in VDI 2035 must be adhered to. Belimo valves are regulating devices. For the valves to function correctly in the long term, they must be kept free from particle debris (e.g. welding beads during installation work). The installation of a suitable strainer is recommended.

**Servicing** Ball valves, rotary actuators and sensors are maintenance-free. Before any service work on the control element is carried out, it is essential to isolate the rotary actuator from the power supply (by unplugging the electrical cable if necessary). Any pumps in the part of the piping system concerned must also be switched off and the appropriate slide valves closed (allow all components to cool down first if necessary and always reduce the system pressure to ambient pressure level). The system must not be returned to service until the ball valve and the rotary actuator have been correctly reassembled in accordance with the instructions and the pipeline has been refilled by professionally trained personnel.

**Flow direction** The direction of flow, specified by an arrow on the housing, is to be complied with, since otherwise the flow rate will be measured incorrectly.

**Cleaning of pipes** Before installing the valve, the circuit must be thoroughly rinsed to remove impurities.

Installation notes

**Prevention of stresses** The valve must not be subjected to excessive stress caused by pipes or fittings.

**Inlet section** There are no requirements for straight inlet sections prior to the flow sensor. Product has been tested to and fulfills the requirements of EN1434-4:2022

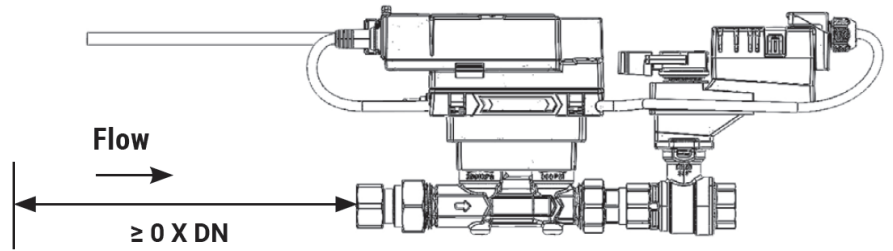

**Split installation** The valve-actuator combination may be mounted separately from the flow sensor. The direction of flow of both components must be observed.

General notes

**Valve selection** The valve is determined using the maximum required flow rate V'max. A calculation of the Cvs value is not required.

$$V'max = 30...100\% \text{ of } V'nom$$

If no hydronic data is available, the same valve DN can be selected as the heat exchanger nominal diameter.

**Behaviour in case of sensor failure** In case of a flow sensor error, the EPIV will switch from flow control to position control. Once the error disappears, the EPIV will switch back to the normal control setting.

Dimensions

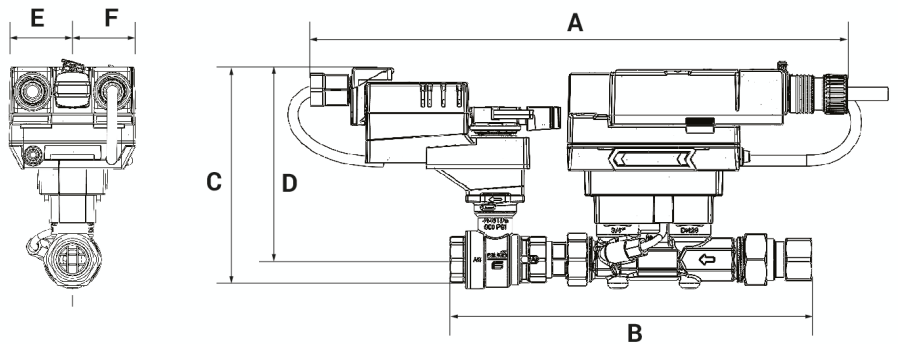

Type	DN		Weight			
EP200H+AKRX-E	2" [50]		15 lb [6.7 kg]			
<b>A</b>	<b>B</b>	<b>C</b>	<b>D</b>	<b>E</b>	<b>F</b>	
18.5" [470]	12.4" [315]	8.0" [203]	6.6" [168]	1.9" [48]	1.9" [48]	