

# MAGNA3

## Model D

Installation and operating instructions





# MAGNA3

---

## English (US)

Installation and operating instructions .....	4
---	---

## English (US) Installation and operating instructions

## Original installation and operating instructions

## Table of contents

<b>1. Limited warranty</b> . . . . .	<b>5</b>	9.10 "Assisted fault advice" . . . . .	60
<b>2. General Information</b> . . . . .	<b>5</b>	<b>10. Servicing the product</b> . . . . .	<b>61</b>
2.1 Hazard statements . . . . .	5	10.1 Differential-pressure and temperature sensor . . . . .	61
2.2 Notes . . . . .	5	10.2 External sensor condition . . . . .	61
2.3 Safety symbols on the pump . . . . .	6	<b>11. Fault finding the product</b> . . . . .	<b>62</b>
<b>3. Receiving the product.</b> . . . . .	<b>6</b>	11.1 Grundfos Eye operating indications . . . . .	62
3.1 Inspecting the product . . . . .	6	11.2 Fault finding . . . . .	63
3.2 Scope of delivery . . . . .	6	11.3 Fault finding table . . . . .	64
3.3 Lifting the pump . . . . .	7	<b>12. Accessories</b> . . . . .	<b>65</b>
<b>4. Installing the product</b> . . . . .	<b>7</b>	12.1 Grundfos GO . . . . .	65
4.1 Location . . . . .	7	12.2 Communication interface module, CIM . . . . .	65
4.2 Tools . . . . .	8	12.3 Pipe connections . . . . .	70
4.3 Insulating shells . . . . .	9	12.4 External sensors . . . . .	71
4.4 Mechanical installation . . . . .	9	12.5 Adapter . . . . .	71
4.5 Positioning the pump . . . . .	10	12.6 Cable for sensors . . . . .	71
4.6 Control box positions . . . . .	11	12.7 Blanking flange . . . . .	71
4.7 Pump head position . . . . .	11	12.8 Insulating kits for applications with ice buildup . . . . .	72
4.8 Changing the control box position . . . . .	12	<b>13. Technical data</b> . . . . .	<b>72</b>
4.9 Electrical installation . . . . .	13	13.1 Sensor specifications . . . . .	73
4.10 Wiring diagrams . . . . .	15	13.2 Markings and approvals . . . . .	74
4.11 Connecting the power supply . . . . .	18	<b>14. Disposing of the product</b> . . . . .	<b>74</b>
4.12 Connecting the external control . . . . .	19		
<b>5. Starting up the product</b> . . . . .	<b>20</b>		
5.1 Single-head pump . . . . .	20		
5.2 Twin-head pump . . . . .	22		
<b>6. Handling and storing the product</b> . . . . .	<b>23</b>		
6.1 Frost protection . . . . .	23		
<b>7. Product introduction.</b> . . . . .	<b>23</b>		
7.1 Applications . . . . .	23		
7.2 Pumped liquids . . . . .	23		
7.3 Pump heads in twin-head pumps . . . . .	24		
7.4 Identification . . . . .	25		
7.5 Model type . . . . .	25		
7.6 Radio communication . . . . .	26		
7.7 Insulating shells . . . . .	26		
7.8 Check valve . . . . .	26		
7.9 Closed-valve operation . . . . .	26		
<b>8. Control functions.</b> . . . . .	<b>27</b>		
8.1 Quick overview of control modes . . . . .	27		
8.2 Operating modes . . . . .	29		
8.3 Control modes . . . . .	29		
8.4 Additional control mode features . . . . .	33		
8.5 Multipump modes . . . . .	35		
8.6 Flow estimation accuracy . . . . .	35		
8.7 External connections . . . . .	36		
8.8 Priority of settings . . . . .	36		
8.9 Input and output communication . . . . .	37		
<b>9. Setting the product.</b> . . . . .	<b>42</b>		
9.1 Operating panel . . . . .	42		
9.2 Menu structure . . . . .	43		
9.3 Startup guide . . . . .	43		
9.4 Menu overview . . . . .	45		
9.5 "Home" menu . . . . .	47		
9.6 Status menu . . . . .	48		
9.7 "Settings" menu . . . . .	49		
9.8 "Assist" menu . . . . .	59		
9.9 "Description of control mode" . . . . .	60		

## 1. Limited warranty

Products manufactured by Grundfos Pumps Corporation (Grundfos) are warranted to the original user only to be free of defects in material and workmanship for a period of 30 months from date of installation, but not more than 36 months from date of manufacture. Grundfos' liability under this warranty shall be limited to repairing or replacing at Grundfos' option, without charge, F.O.B. Grundfos' factory or authorized service station, any product of Grundfos manufacture. Grundfos will not be liable for any costs of removal, installation, transportation, or any other charges that may arise in connection with a warranty claim.

Products which are sold, but not manufactured by Grundfos, are subject to the warranty provided by the manufacturer of said products and not by Grundfos' warranty.

Grundfos will not be liable for damage or wear to products caused by abnormal operating conditions, accident, abuse, misuse, unauthorized alteration or repair, or if the product was not installed in accordance with Grundfos' printed installation and operating instructions and accepted codes of good practice. The warranty does not cover normal wear and tear.

To obtain service under this warranty, the defective product must be returned to the distributor or dealer of Grundfos' products from which it was purchased together with proof of purchase and installation date, failure date and supporting installation data. Unless otherwise provided, the distributor or dealer will contact Grundfos or an authorized service station for instructions. Any defective product to be returned to Grundfos or a service station must be sent freight prepaid; documentation supporting the warranty claim and/or a Return Material Authorization must be included if so instructed.

Grundfos will not be liable for any incidental or consequential damages, losses, or expenses arising from installation, use, or any other causes. There are no express or implied warranties, including merchantability or fitness for a particular purpose, which extend beyond those warranties described or referred to above. Some jurisdictions do not allow the exclusion or limitation of incidental or consequential damages and some jurisdictions do not allow limitations on how long implied warranties may last. Therefore the above limitations or exclusions may not apply to you. This warranty gives you specific legal rights and you may also have other rights which vary from jurisdiction to jurisdiction.

Products which are repaired or replaced by Grundfos or authorized service center under the provisions of these limited warranty terms will continue to be covered by Grundfos warranty only through the remainder of the original warranty period set forth by the original purchase date.

## 2. General Information

### Target group



Read this document before you install the product. Installation and operation must comply with local regulations and accepted codes of good practice.

This appliance can be used by children aged from 8 years and above and persons with reduced physical, sensory or mental capabilities or lack of experience and knowledge if they have been given supervision or instruction concerning use of the appliance in a safe way and understand the hazards involved.

Children shall not play with the appliance.

Cleaning and user maintenance shall not be made by children without supervision.



### 2.1 Hazard statements

The symbols and hazard statements below may appear in Grundfos installation and operating instructions, safety instructions and service instructions.



#### DANGER

Indicates a hazardous situation which, if not avoided, will result in death or serious personal injury.



#### WARNING

Indicates a hazardous situation which, if not avoided, could result in death or serious personal injury.



#### CAUTION

Indicates a hazardous situation which, if not avoided, could result in minor or moderate personal injury.

The hazard statements are structured in the following way:



#### SIGNAL WORD

##### Description of the hazard

Consequence of ignoring the warning

- Action to avoid the hazard.

### 2.2 Notes

The symbols and notes below may appear in Grundfos installation and operating instructions, safety instructions and service instructions.



Observe these instructions for explosion-proof products.



A blue or grey circle with a white graphical symbol indicates that an action must be taken.



A red or grey circle with a diagonal bar, possibly with a black graphical symbol, indicates that an action must not be taken or must be stopped.



If these instructions are not observed, it may result in malfunction or damage to the equipment.



Tips and advice that make the work easier.

## 2.3 Safety symbols on the pump



Check the position of the clamp before you tighten it. Incorrect position of the clamp will cause leakage from the pump and damage the hydraulic parts in the pump head.



Fit and tighten the screw that holds the clamp to  $6 \pm 0.7$  ft-lbs ( $8 \pm 1$  Nm).



Do not apply more torque than specified even though water is dripping from the clamp. The condensed water is most likely coming from the drain hole under the clamp.

## 3. Receiving the product

### 3.1 Inspecting the product

Check that the product received is in accordance with the order. Check that the voltage and frequency of the product match voltage and frequency of the installation site. See section Nameplate.



Pumps tested with water containing anticorrosive additives are taped on the inlet and outlet ports to prevent residual test water from leaking into the packaging. Remove the tape before installing the pump.

### Related information

[7.4.1 Nameplate](#)

### 3.2 Scope of delivery

#### 3.2.1 Terminal-connected single-head pump



TM067226

The box contains the following items:

- MAGNA3 pump
- insulating shells
- quick guide
- safety instructions
- box with terminal and cable glands
- conduit adapter, 20 mm to 1/2" NPT.

#### 3.2.2 Terminal-connected twin-head pump



TM067227

The box contains the following items:

- MAGNA3 pump
- quick guide
- safety instructions
- two boxes with terminals and cable glands
- conduit adapter, 20 mm to 1/2" NPT.

#### 3.2.3 Wire-to-wire-connected single-head pump



TM070355

The box contains the following items:

- MAGNA3 pump
- insulating shells
- gaskets
- quick guide
- safety instructions.

### 3.3 Lifting the pump



Observe local regulations concerning limits for manual lifting or handling.

Always lift directly on the pump head or the cooling fins when handling the pump. See figure below.

For large pumps, it may be necessary to use lifting equipment. Position the lifting straps as illustrated in figure below.



*Correct lifting of the pump*



Do not lift the pump head by the control box, i.e. the red area of the pump. See figure below.



*Incorrect lifting of the pump*

## 4. Installing the product

### 4.1 Location

The pump is designed for indoor installation.

Always install the pump in a dry environment where it will not be exposed to drops or splashes, for example water, from surrounding equipment or structures.

As the pump contains stainless steel parts, it is important that it is not installed directly in environments, such as:

- Indoor swimming pools where the pump would be exposed to the ambient environment of the pool.
- Locations with direct and continuous exposure to a marine atmosphere.
- In rooms where hydrochloric acid (HCl) can form acidic aerosols escaping from, for example, open tanks or frequently opened or vented containers.

The above applications do not disqualify for installation of MAGNA3. However, it is important that the pump is not installed directly in these environments.

Stainless-steel variants of MAGNA3 can be used to pump pool water. See section Pumped liquids.

To ensure adequate cooling of the motor and electronics, observe the following requirements:

- Position the pump in such a way that sufficient cooling is ensured.
- The ambient temperature must not exceed 104 °F (40 °C).

#### Related information

#### [7.2 Pumped liquids](#)

#### 4.1.1 Outdoor installation

the pump is intended for indoor installation. However, if the pump is installed outside, please observe the following

- Make sure the environmental conditions and protection class are at a under permissible level.
- Install pump and housing/cover around pump as weather protection. Housing/cover need to be installed separately and is not provided by Grundfos.
- Ambient temperatures below 14 °F (-10 °C) is not permitted and below -4 °F (-20 °C) needs glycol mixture.
- Protect the pump from direct exposure to sunlight, snow & rain.
- Implement required steps to remove water condensation.
- Keep the drain hole free of dust.
- Do not expose the pump to UV radiation.

#### 4.1.2 Minimum clearance

MAGNA requires the following space on the installation sit as shown below.

TM055820

TM055821

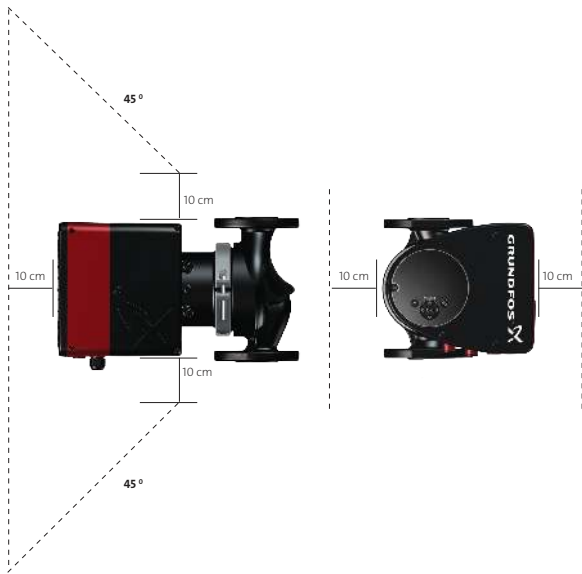

TM060059

Minimum clearance around Single head pump

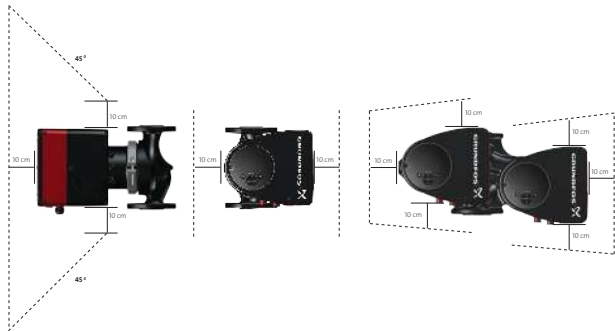

TM060058





Minimum clearance around Twin-head pump

### 4.1.3 Cooling applications

In cooling applications condensation may occur on the surface of the pump.

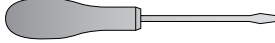
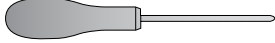
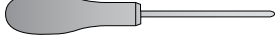
To protect the electronics, power on the pump must be switched on, if the cold water is forced through the pump

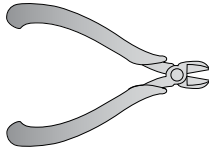
### 4.2 Tools

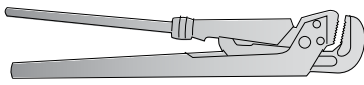
- 1  0.6 × 3.5
- 2  1.2 × 8.0
- 3  TX10
- 3  TX20
- 4  5.0
- 5 
- 6 
- 7 

TM056472

### Recommended tools

Pos.	Tool	Size
1	Screwdriver, straight slot	0.6 x 3.5 mm
2	Screwdriver, straight slot	1.2 x 8.0 mm
3	Screwdriver, torx bit	TX10
4	Screwdriver, torx bit	TX20
5	Hexagon key	5.0 mm
6	Wire cutter	
7	Open-end wrench	Depending on bolt size
8	Pipe wrench	Only used for pumps with unions

### 4.3 Insulating shells

Pumps for heating systems are factory-fitted with insulating shells. Insulating shells are available for single-head pumps only. Remove the insulating shells before you install the pump. See figure below.

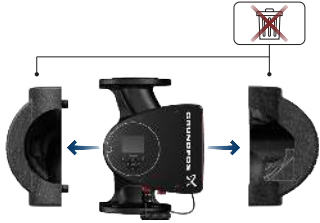

Removing insulating shells from the pump



Insulating shells increase the pump dimensions.

As an alternative to insulating shells, you can insulate the pump housing and pipes as section Mechanical installation.

#### Related information

[4.4 Mechanical installation](#)

### 4.4 Mechanical installation

The pump range includes flanged versions.

Install the pump so that it is not stressed by the pipes. For maximum permissible forces and moments for pipe connections acting on the pump flanges, see Appendix.

You can suspend the pump directly in the pipes, provided that the pipes support the pump.

Twin-head pumps are prepared for installation on a mounting bracket or base plate. The pump housing has an M12 thread.

To ensure adequate cooling of the motor and electronics, observe the following requirements:

- Make sure that the control box is in horizontal position with the Grundfos logo in vertical position. See section Control box positions.
- The ambient temperature must not exceed 104 °F (40 °C).

TM052859

Step	Action	Illustration
1	Arrows on the pump housing indicate the flow direction through the pump. The flow direction can be horizontal or vertical, depending on the control box position.	<p style="text-align: right;">TM058456</p>
2	Close the isolating valves and make sure that the system is not pressurized during the installation of the pump.	<p style="text-align: right;">TM052863</p>
3	Mount the pump with gaskets in the pipes.	<p style="text-align: right;">TM052864</p>
4	Flanged version: Fit bolts and nuts. Use the right size of bolts according to system pressure. For further information about torques, see Appendix.	<p style="text-align: right;">TM058455</p>

Step	Action	Illustration
5	Fit the insulating shells.	

TM052874

As an alternative to insulating shells, you can insulate the pump housing and pipes as illustrated in figure below.



Do not insulate the control box or cover the operating panel.



TM052889

Insulation of the pump housing and pipe

**Related information**

[4.6 Control box positions](#)

**4.5 Positioning the pump**

Always install the pump with a horizontal motor shaft.

- Pump installed correctly in a vertical pipe. See figure (A).
- Pump installed correctly in a horizontal pipe. See figure (B).
- Do not install the pump with a vertical motor shaft. See figure (C and D).

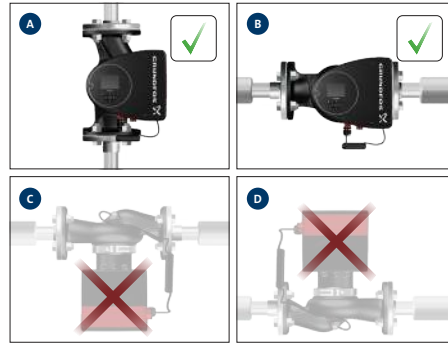

Pump installed with a horizontal motor shaft

TM080515

### 4.6 Control box positions

To ensure adequate cooling, make sure that the control box is in horizontal position with the Grundfos logo in vertical position. See figure below.

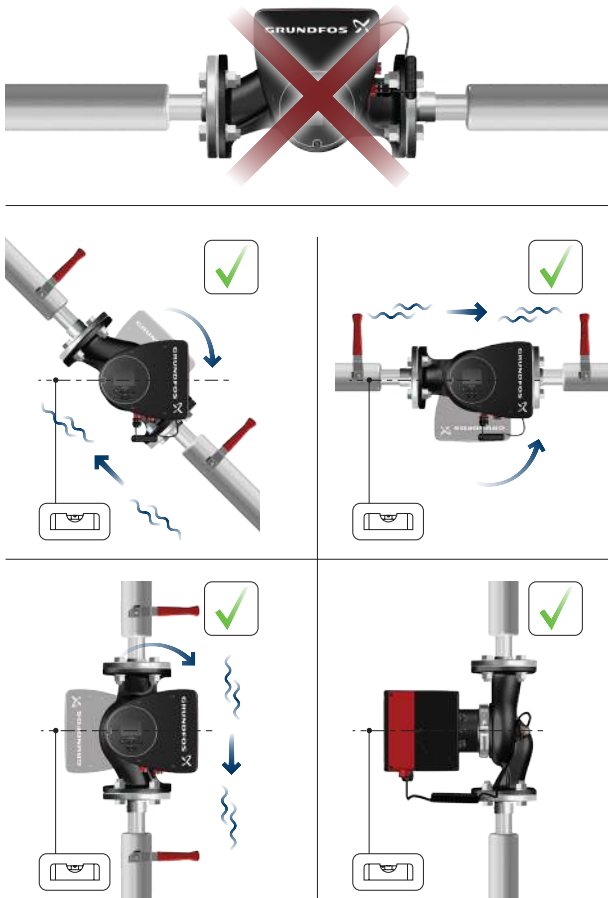

Pump with the control box in horizontal position

TM052915



For twin-head pumps installed in horizontal pipes, air may be trapped in the pump housing. Therefore, an automatic vent, Rp 1/4 thread, must be installed in the upper part of the pump housing. See figure below.



Automatic vent

TM056061

### 4.7 Pump head position

If you remove the pump head before installing the pump in the pipes, pay special attention when fitting the pump head to the pump housing:

1. Visually check that the floating ring in the sealing system is centered. See figures below.



Correctly centered sealing system

TM056650



Incorrectly centered sealing system

TM056651

2. Gently lower the pump head with rotor shaft and impeller into the pump housing.
3. Make sure that the contact face of the pump housing and that of the pump head are in contact before you tighten the clamp. See figure below.



Observe the position of the clamp before you tighten it. Incorrect position of the clamp will cause leakage from the pump and damage the hydraulic parts in the pump head. See figure below.



TM082066

Fitting the pump head to the pump housing

4.8 Changing the control box position



The warning symbol on the clamp holding the pump head and pump housing together indicates that there is a risk of personal injury. See specific warnings below.

**CAUTION**

**Crushing of feet**

Minor or moderate personal injury

- Do not drop the pump head when loosening the clamp.



**CAUTION**

**Pressurized system**

Minor or moderate personal injury

- Pay special attention to any escaping vapor when loosening the clamp.



Fit and tighten the screw that holds the clamp to  $6 \pm 0.7$  ft-lbs ( $8 \pm 1$  Nm). Do not apply more torque than specified even though water is dripping from the clamp. The condensation is most likely coming from the drain hole under the clamp.



Check the position of the clamp before you tighten the clamp. Incorrect position of the clamp will cause leakage from the pump and damage the hydraulic parts in the pump head.



Make sure that the isolating valves are closed before rotating the control box. The pump must be pressureless before the control box is rotated. Drain the system or relieve the pressure inside the pump housing by loosening the thread or flange.

Step	Action	Illustration
------	--------	--------------

- 1 Loosen the screw in the clamp that holds the pump head and pump housing together. If you loosen the screw too much, the pump head will be completely disconnected from the pump housing.



TM052867

- 2 Carefully turn the pump head to the desired position. If the pump head is stuck, loosen it with a light blow of a rubber mallet.



TM082076

- 3 Place the control box in horizontal position so that the Grundfos logo is in vertical position. The motor shaft must be in horizontal position.

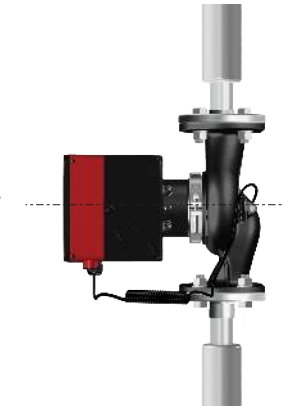

TM052869

- 4 Due to the drain hole in the stator housing, position the gap of the clamp as shown in step 4a or 4b.

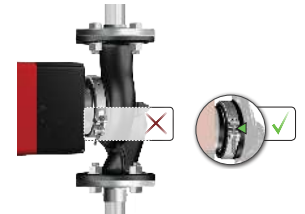

TM052870

- 4a Single-head pump. Position the clamp so that the gap points towards the arrow. It can be in position 3, 6, 9 or 12 o'clock.

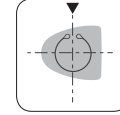
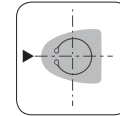
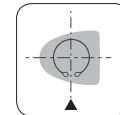
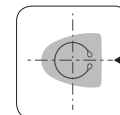

TM052918

Step	Action	Illustration
4b	Twin-head pump. Position the clamps so that the gaps point towards the arrows. They can be in position 3, 6, 9 or 12 o'clock.	
5	Fit and tighten the screw that holds the clamp to $6 \pm 0.7$ ft-lbs ( $8 \pm 1$ Nm). Do not retighten the screw if condensation is dripping from the clamp.	
6	Fit the insulating shells.	

TM052917

TM052872

TM080511

## 4.9 Electrical installation

Carry out the electrical connection and protection according to local regulations.

Check that the supply voltage and frequency correspond to the values stated on the nameplate.

### WARNING

#### Warning

Electric shock



- Before starting any work on the product, make sure that the power supply has been switched off. Lock the main disconnect switch to the Off position. Type and requirements as specified in national, state, and local regulations.

### WARNING

#### Warning

Electric shock



- Connect the pump to an external main disconnect switch with a minimum contact gap of 1/8 inch (3 mm) in all poles.
- The ground terminal of the pump must be connected to ground. Use grounding or neutralization for protection against indirect contact.

### WARNING

#### Warning

Electric shock



- Use a suitable type of Ground Fault Circuit Interrupter (GFCI) capable of handling ground fault currents with a DC content (pulsating DC).
- If the pump is connected to an electrical installation where a GFCI is used for additional protection, this GFCI must be able to trip when ground fault currents with DC content occur.



Make sure that the fuse is dimensioned according to the nameplate and local legislation.



Connect all cables in accordance with local regulations.



Make sure that all cables are heat-resistant up to 158 °F (70 °C).

Install all cables in accordance with the National Electrical Code, or in Canada, the Canadian Electrical Code, and state and local regulations.

- If rigid conduit is to be used, the hub must be connected to the conduit system before it is connected to the terminal box of the pump.
- Make sure that the pump is connected to an external main disconnect switch.
- The pump requires no external motor protection.
- The motor incorporates thermal protection against slow overloading and blocking.
- When switched on via the power supply, the pump starts pumping after approximately 5 seconds.

**4.9.1 Supply voltage**

1 x 115-230 V  $\pm$  10 %, 60 Hz\*, PE. Check that the supply voltage and frequency correspond to the values stated on the nameplate.

The voltage tolerances are intended for mains-voltage variations. Do not use the voltage tolerances for running pumps at other voltages than those stated on the nameplate.

\* All MAGNA3 pumps are approved to run on both 50 and 60 Hz.

## 4.10 Wiring diagrams

### 4.10.1 Connections in the control box, terminal-connected versions

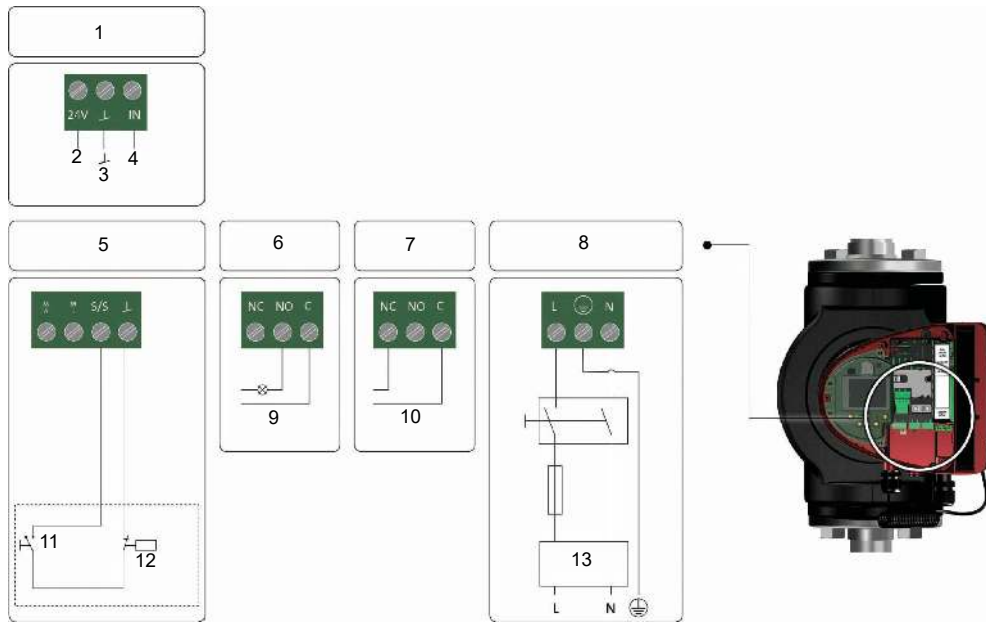

TM070364

Example of connections in the control box of terminal-connected versions

Pos.	Description
1	Analog input
2	Vcc
3	Sensor
4	Signal
5	Digital input
6	Relay 1
7	Relay 2
8	Power
9	Operation
10	Alarm
11	Start/stop
12	On/off timer
13	GFCI



Use C and NC for fault signals as this enables serial connections of more relays and detection of signal cable defects.

For further information on digital and analog inputs, see sections Digital inputs and Analog input.

For information on relay outputs, see section Relay outputs.

#### Related information

[8.9.3 Digital inputs](#)

[8.9.4 Analog input](#)

[8.9.2 Relay outputs](#)

## 4.10.2 Connection to power supply, wire-to-wire-connected motor

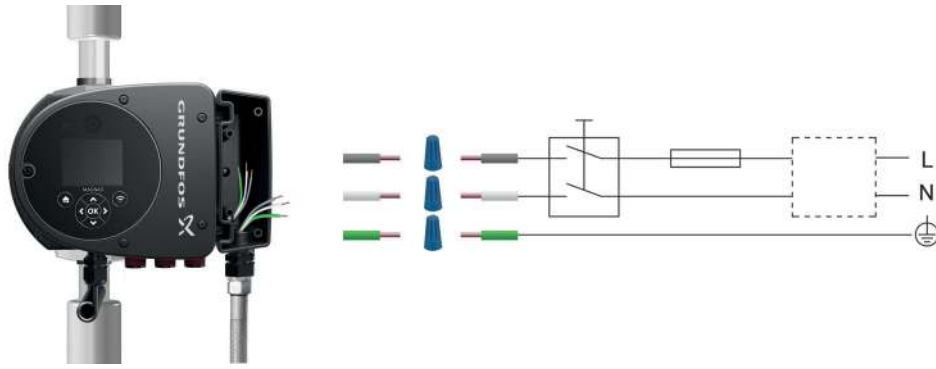

TM071415

*Example of wire-to-wire-connected motor with main disconnect switch, backup fuse and additional protection*

Pos.	Description
1	External switch
2	Fuse
3	GFCI

#### 4.10.3 Connections in the control box, wire-to-wire-connected motor

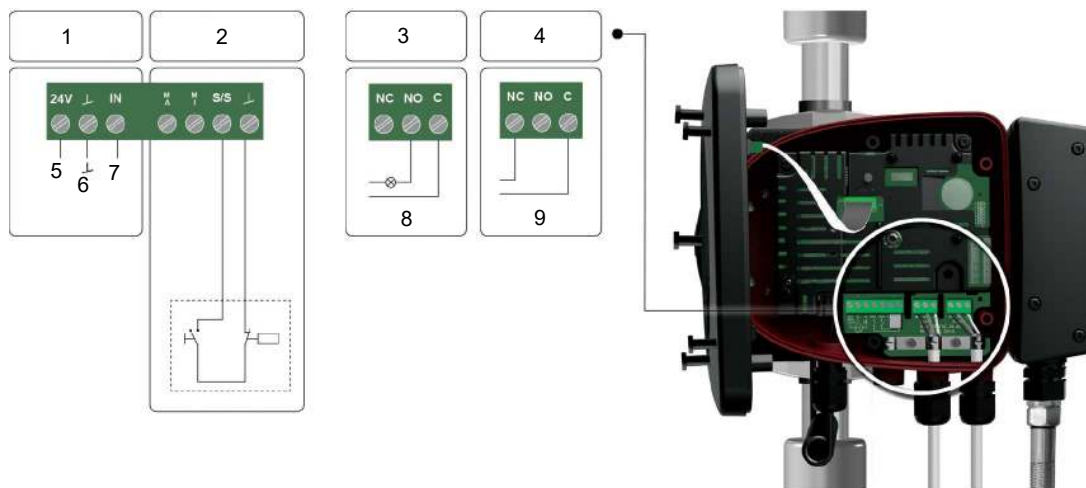

Wiring diagram, models with wire-to-wire connections

Pos.	Description
1	Analog input
2	Digital input
3	Relay 1
4	Relay 2
5	Vcc
6	Sensor
7	Signal
8	Operation
9	Alarm



Use C and NC for fault signals as this enables serial connections of more relays and detection of signal cable defects.

For further information on digital and analog inputs, see sections Digital inputs and Analog input.

For information on relay outputs, see section Relay outputs.

#### Related information



[8.9.3 Digital inputs](#)

[8.9.4 Analog input](#)

[8.9.2 Relay outputs](#)

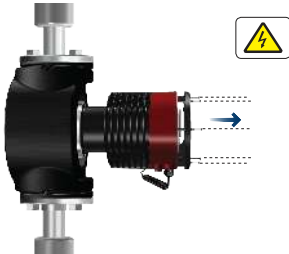
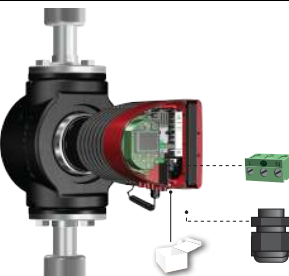
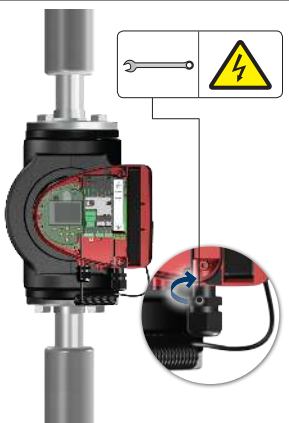

TM071623

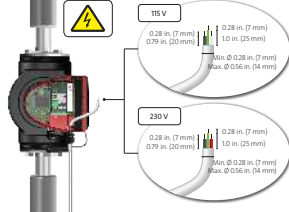
### 4.11 Connecting the power supply

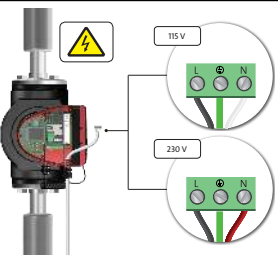
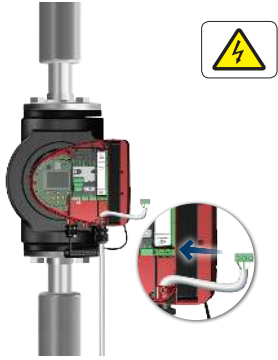
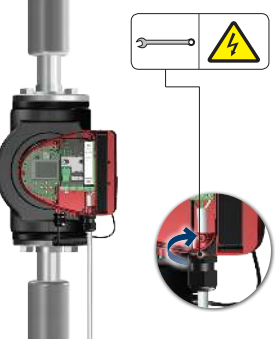
Step	Action	Illustration
1	Remove the front cover from the control box. Do not remove the screws from the cover.	
2	Locate the power supply plug and cable gland in the small cardboard box supplied with the pump.	
3	Connect the cable gland to the control box.	
4	Pull the power supply cable through the cable gland.	
5	Strip the cable conductors as illustrated.	

Step	Action	Illustration
6	Connect the cable conductors to the power supply plug.	
7	Insert the power supply plug into the male plug in the pump control box.	
8	Tighten the cable gland. Fit the front cover.	

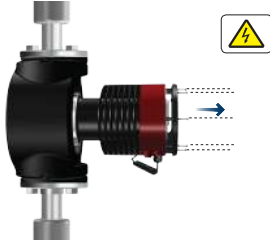
## 4.12 Connecting the external control

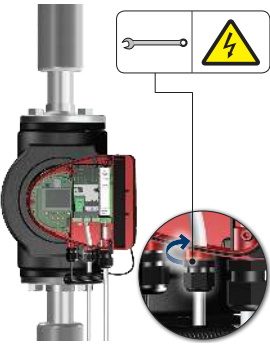
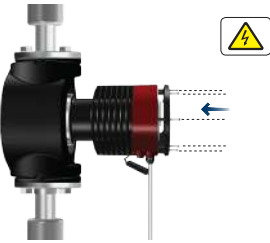
Step	Action	Illustration
1	Remove the front cover from the control box. Do not remove the screws from the cover.	
2	Locate the digital input terminal connector.	
3	Pull the cable through a M16 cable gland and one of the cable entries on the pump. Take out the desired terminal, connect the cable conductors and reinsert the terminal. See sections <a href="#">External connections</a> and <a href="#">Input and output communication</a> for instructions on how to connect the cable to the different terminals in the pump.	
4	Tighten the cable gland.	
5	Refit the front cover to the control box.	

### Related information

[8.7 External connections](#)

[8.9 Input and output communication](#)

## 5. Starting up the product

### 5.1 Single-head pump







The number of starts and stops via the power supply must not exceed four times per hour.

Do not start the pump until the system has been filled with liquid and vented. Furthermore, the required minimum inlet pressure must be available at the pump inlet. See section Accessories.

Flush the system with clean water to remove all impurities before you start the pump.

The pump is self-venting through the system, and the system must be vented at the highest point.

Step	Action	Illustration
1	<p>Switch on the power supply to the pump.</p> <p>The pump has been factory set to "AUTOADAPT" mode, which starts after approximately 5 seconds.</p>	
2	<p>Operating panel at first startup.</p> <p>After a few seconds, the pump display changes to the startup guide.</p>	
3	<p>The startup guide guides you through the general settings of the pump, such as language, date and time.</p> <p>If you do not touch the buttons on the operating panel for 15 minutes, the display goes into sleep mode. When you touch a button, the "Home" display appears.</p>	
4	<p>When you have made the general settings, select the desired control mode or let the pump run in AUTOADAPT mode.</p> <p>For additional settings, see section Control functions.</p>	

#### Related information

- [TOPIC NOT IN MAP (empty topicContent)]  
href=reference-KJC0WEx.dita
- [TOPIC NOT IN MAP (empty topicContent)]

*href=reference-KJC0WEx.dita*

## *8.1 Quick overview of control modes*

*12.1 Grundfos GO*

*12.1 Grundfos GO*

*12.1 Grundfos GO*

## 5.2 Twin-head pump



TM082057

The pumps are paired from factory. When switching on the power supply, the heads will establish connection. Please allow approximately 5 seconds for this to happen.

Flush the system with clean water to remove all impurities before you start the pump.

### 5.2.1 Multipump pairing

**Note:** Available for pumps with production code from 1838 (Model D and Model E can be paired).

After turning on the power supply, the pump's initial setup menu asks you whether or not you want to keep multipump system activated. Several scenarios can play out.

#### Keep multipump system

- **Only one pump head is connected to the power supply.**  
If you have not connected both pump heads to the power supply and you choose to keep the multipump system, warning 77 appears in the display. See figure below. Connect the second pump head. Once both pumps are on, the pump heads will establish connection and the warning deactivates.
- **Both pump heads are connected to the power supply.**  
Configuring is only necessary from one of the pump heads.

#### Dissolve multipump system

- **Only one pump head is connected to the power supply.**  
If you have not connected both pump heads to the power supply and you choose to dissolve the multipump system, the second pump head, if connected to the power supply, will ask you whether or not you want to keep the multipump system. Choose to dissolve the multipump system.
- **Both pump heads are connected to the power supply.**  
Configuring is only necessary from one of the pump heads.

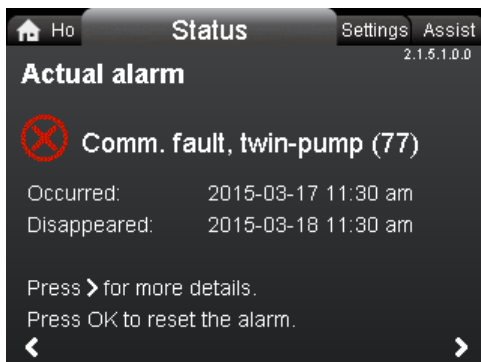

Warning 77

See sections Digital inputs, Relay outputs and Multipump modes for additional twin-head pump setup options.

### Related information

- [\[TOPIC NOT IN MAP \(empty topicContent\)\]](#)  
[href=reference-LBkpiX7.dita](reference-LBkpiX7.dita)
- [\[TOPIC NOT IN MAP \(empty topicContent\)\]](#)  
[href=reference-WtvxQoP.dita](reference-WtvxQoP.dita)
- [\[TOPIC NOT IN MAP \(empty topicContent\)\]](#)  
[href=concept-7uKmts.u.dita](concept-7uKmts.u.dita)
- [\[TOPIC NOT IN MAP \(empty topicContent\)\]](#)  
[href=reference-LBkpiX7.dita](reference-LBkpiX7.dita)
- [\[TOPIC NOT IN MAP \(empty topicContent\)\]](#)  
[href=reference-WtvxQoP.dita](reference-WtvxQoP.dita)
- [\[TOPIC NOT IN MAP \(empty topicContent\)\]](#)  
[href=concept-7uKmts.u.dita](concept-7uKmts.u.dita)

#### [8.5.1 Multipump function](#)

#### [8.9.3 Digital inputs](#)

#### [8.9.2 Relay outputs](#)

### 5.2.2 Configuring twin-head pumps

If you replace a pump head of a twin-head pump, the twin-head pump will function as two single pumps until you have configured the pump heads and warning 77 is shown in the pump display. See figure above.

To establish communication between the pump heads, run the multipump setup via the "Assist" menu. The pump from which you run the setup will be the master pump. See section "Multipump setup".

#### Related information

- [TOPIC NOT IN MAP (empty topicContent)]

[href=task-g50ZZym.dita](task-g50ZZym.dita)

- [TOPIC NOT IN MAP (empty topicContent)]

[href=task-g50ZZym.dita](task-g50ZZym.dita)

[9.8.3 "Multipump setup"](#)

## 6. Handling and storing the product

### 6.1 Frost protection



If the pump is not used during periods of frost, take the necessary steps to prevent frost bursts.

## 7. Product introduction

MAGNA3 is a complete range of circulator pumps with integrated controller enabling adjustment of pump performance to the actual system requirements. In many systems, this reduces the power consumption considerably, reduces noise from thermostatic radiator valves and similar fittings and improves the control of the system.

You can set the desired head on the pump operating panel.

### 7.1 Applications

The pump is designed for circulating liquids in the following systems:

- heating systems
- domestic hot-water systems
- air-conditioning and cooling systems.

You can also use the pump in the following systems:

- ground-source heat-pump systems
- solar-heating systems.

### 7.2 Pumped liquids

The pump is suitable for thin, clean, non-aggressive and non-explosive liquids, not containing solid particles or fibers that may attack the pump mechanically or chemically.

In heating and cooling systems, the water must meet the requirements of accepted standards, codes, and any authority having jurisdiction (AHJ) requirements.

The pumps are also suitable for domestic hot-water systems.



Observe local legislation regarding pump housing material.

We strongly recommend that you use stainless-steel pumps in domestic hot-water applications to avoid corrosion.

In domestic hot-water systems, we recommend that you use the pump only for water with a degree of hardness lower than approximately 14 °dH.

In domestic hot-water systems, we recommend that you keep the liquid temperature below 149 °F (65 °C) to eliminate the risk of lime precipitation.



Do not pump aggressive liquids.



Do not pump flammable, combustible or explosive liquids.

### 7.2.1 Glycol

You can use the pump for pumping water-ethylene-glycol mixtures up to 50 %.

Example of a water-ethylene-glycol mixture:

Maximum viscosity: 50 cSt ~ 50 % water/50 % ethylene-glycol mixture at 50 °F (-10 °C).

The pump has a power-limiting function that protects it against overload.

The pumping of water-ethylene-glycol mixtures affects the maximum curve and reduces the performance, depending on the water-ethylene-glycol mixture and the liquid temperature.

To prevent the ethylene-glycol mixture from degrading, avoid temperatures exceeding the rated liquid temperature and minimize the operating time at high temperatures.

Clean and flush the system before you add the ethylene-glycol mixture.

To prevent corrosion or lime precipitation, maintain the ethylene-glycol mixture regularly. If further dilution of the supplied ethylene-glycol is required, follow the glycol supplier's instructions.

**!** Additives with a density and/or kinematic viscosity higher than those/that of water reduce the hydraulic performance.



*Pumped liquids, flanged version*

### 7.3 Pump heads in twin-head pumps

The twin-head pump housing has a flap valve on the outlet side. The flap valve seals off the port of the idle pump housing to prevent the pumped liquid from running back to the inlet side. See figure below.



*Twin-head pump housing with flap valve*

Due to the flap valve, there is a difference in the hydraulics between the two pump heads. See figure below.

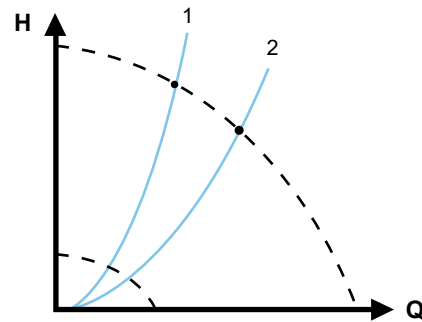

*Hydraulic difference between the two pump heads*

Pos.	Description
1	Right pump head
2	Left pump head

TM082063

TM061565

TM061566

## 7.4 Identification

### 7.4.1 Nameplate

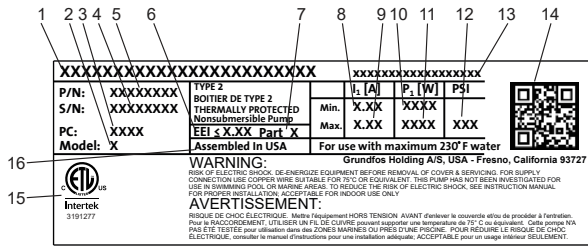

Example of the nameplate

Pos.	Description
1	Product name
2	Model
3	Production code, year and week *
4	Serial number
5	Product number
6	Energy Efficiency Index (EEI)
7	Part (according to EEI)
8	Minimum current [A]
9	Maximum current [A]
10	Minimum power [W]
11	Maximum power [W]
12	Maximum system pressure
13	Voltage [V] and frequency [Hz]
14	QR code
15	Approvals
16	Assembled in USA

\* Example of production code: 1326. The pump was produced in week 26, 2013.



Production code on the packaging

## 7.5 Model type

These installation and operating instructions describe MAGNA3 model D. The model version is stated on the nameplate.



Model type on the product

TM06946

TM067734

TM067998

## 7.6 Radio communication

GRUNDFOS HOLDING A/S

RADIOMODULE 2G4

CONTAINS FCC ID: OG3-RA2G4MSR

CONTAINS IC: 10447A-RA2G4MSR

This device complies with part 15 of the FCC Rules and Licence exempts RSSs of ISED rules.

Operation is subject to the following two conditions:

(1) This device may not cause harmful interference, and (2) this device must accept any interference received, including interference that may cause undesired operation of the device.

### USA, CLASS B product (domestic use / public access)

This equipment has been tested and found to comply with the limits for a Class B digital device, pursuant to part 15 of the FCC Rules. These limits are designed to provide reasonable protection against harmful interference in a residential installation. This equipment generates, uses, and can radiate radio frequency energy and, if not installed and used in accordance with the instructions, may cause harmful interference to radio communications. However, there is no guarantee that interference will not occur in a particular installation. If this equipment does cause harmful interference to radio or television reception, which can be determined by turning the equipment off and on, the user is encouraged to try to correct the interference by one or more of the following measures:

- Reorient or relocate the receiving antenna.
- Increase the separation between the equipment and receiver.
- Connect the equipment into an outlet on a circuit different from that to which the receiver is connected.
- Consult the dealer or an experienced radio/TV technician for help.

### Canada

Complies with the Canadian ICES-003 Class B specifications. This Class B device meets all the requirements of the Canadian interference-causing equipment regulations.

### Intended use

This pump incorporates a radio for remote control.

The pump can communicate with Grundfos GO and with other MAGNA3 pumps of the same type via the built-in radio.

## 7.7 Insulating shells

Insulating shells are available for single-head pumps only.



Limit the heat loss from the pump housing and pipes.

Reduce the heat loss by insulating the pump housing and the pipes. See section Mechanical installation.

- Insulating shells for pumps in heating systems are supplied with the pump.
- Insulating shells for applications with ice buildup are available as an accessory. See section Disposing of the product.

The fitting of insulating shells increases the pump dimensions.

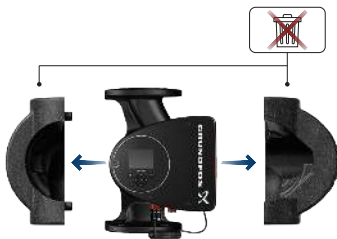

Insulating shells

Pumps for heating systems are factory-fitted with insulating shells. Remove the insulating shells before installing the pump.

### Related information

[4.4 Mechanical installation](#)

[14. Disposing of the product](#)

## 7.8 Check valve

If a check valve is fitted in the pipe system, make sure that the set minimum outlet pressure of the pump is always higher than the closing pressure of the valve. See figure below. This is especially important in proportional-pressure control mode with reduced head at low flow.

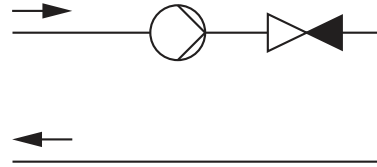

Check valve

## 7.9 Closed-valve operation

MAGNA3 pumps can operate at any speed against a closed valve for several days without damage to the pump. However, Grundfos recommends to operate at the lowest possible speed curve to minimize energy losses. There are no minimum flow requirements.



Do not close inlet and outlet valves simultaneously, always keep one valve open when the pump is running to avoid pressure buildup.

Media- and ambient temperatures must never exceed the specified temperature range.

TM052859

TM053055

## 8. Control functions

### 8.1 Quick overview of control modes

#### AUTOADAPT

- We recommend this control mode for most heating systems.
- During operation, the pump automatically makes the necessary adjustment to the actual system characteristic.

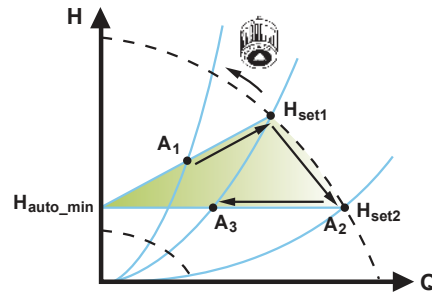

For further information, see section [8.3.2 AUTOADAPT](#).

#### FLOWADAPT

The FLOWADAPT control mode combines a control mode and a function:

- The pump is running in AUTOADAPT
- The delivered flow from the pump will never exceed a selected FLOW *LIMIT*.

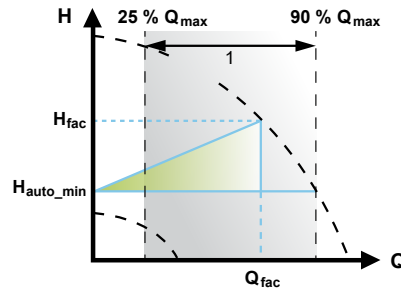

For further information, see section [8.3.3 FLOWADAPT](#).

#### Proportional pressure

- This control mode is used in systems with relatively large pressure losses in the distribution pipes.
- The head of the pump will increase proportionally to the flow in the system to compensate for the large pressure losses in the distribution pipes.

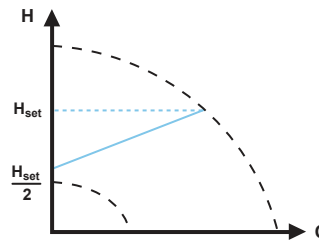

For further information, see section [8.3.4 Proportional pressure](#).

#### Constant pressure

- We recommend this control mode in systems with relatively small pressure losses.
- The pump head is kept constant, independent of the flow in the system.

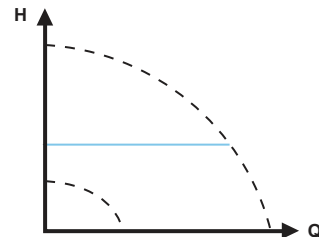

For further information, see section [8.3.5 Constant pressure](#).

#### Constant temperature

In systems with a fixed system characteristic, for example domestic hot-water systems, the control of the pump according to a constant return-pipe temperature is relevant.

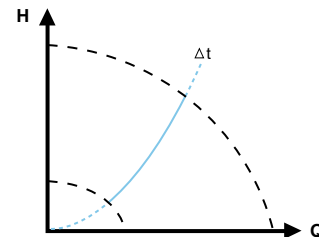

For further information, see section [8.3.6 Constant temperature](#).

#### Differential temperature

- This control mode ensures a constant differential temperature drop across heating and cooling systems.
- The pump will maintain a constant differential temperature between the pump and the external sensor.

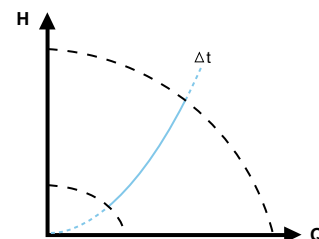

For further information, see section [8.3.7 Differential temperature](#).

### Constant flow

**Note:** Available for pumps with production code from 1838.

- The pump maintains a constant flow in the system independently of the head.

It is not possible to use an external sensor, instead, the pump uses its internal sensor.

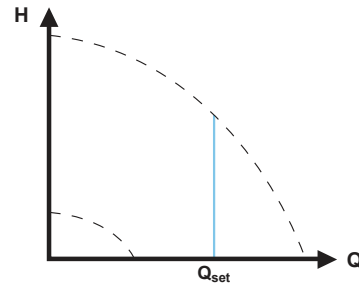

For further information, see section [8.3.8 Constant flow](#).

### Constant curve

- The pump can be set to operate according to a constant curve, like an uncontrolled pump.
- Set the desired speed in % of the maximum speed in the range from minimum to 100 %.

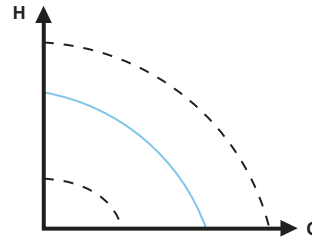

For further information, see section [8.3.9 Constant curve](#).

### Multipump modes

- Alternating operation:**  
Only one pump is operating at a time.
- Backup operation:**  
One pump is operating continuously. In the event of a fault, the backup pump starts automatically.
- Cascade operation:**  
The pump performance is automatically adapted to the consumption by switching pumps on and off.

For further information, see section [8.5.1 Multipump function](#).

## 8.2 Operating modes

### Normal

The pump runs according to the selected control mode.



You can select the control mode and setpoint even if the pump is not running in **Normal** mode.

### Stop

The pump stops.

### Min.

You can use the minimum curve mode in periods in which a minimum flow is required. This operating mode is for instance suitable for manual night setback if automatic night setback is not desired.

The minimum curve can be adjusted. See section Operating modes.

### Max.

You can use the maximum curve mode in periods in which a maximum flow is required. This operating mode is for instance suitable for hot-water priority.

The maximum curve can be adjusted. See section Operating modes.

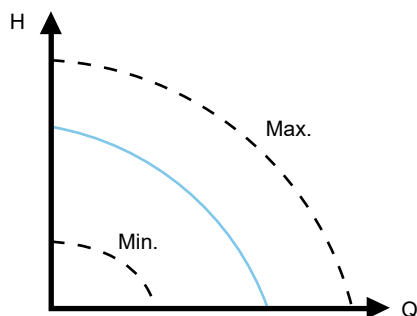

Maximum and minimum curves

### Related information

[9.7.2 "Operating mode"](#)

[9.7.2 "Operating mode"](#)

[9.7.2 "Operating mode"](#)

## 8.3 Control modes

### 8.3.1 Factory setting

The pumps have been factory-set to AUTOADAPT without automatic night setback, which is suitable for most installations.

The setpoint has been factory-set. See section Flow estimation accuracy.

### Related information

[8.6 Flow estimation accuracy](#)

### 8.3.2 AUTOADAPT

We recommend the AUTOADAPT control mode for most heating systems, especially in systems with relatively large pressure losses in the distribution pipes, and in replacement situations where the proportional-pressure duty point is unknown.

This control mode has been developed specifically for heating systems and we do not recommend it for air-conditioning and cooling systems.

### Characteristics and key benefits

- Automatically adjusts the pump to actual system characteristics.
- Ensures minimum energy consumption and a low noise level.
- Reduced operating costs and increased comfort.

### Technical specifications

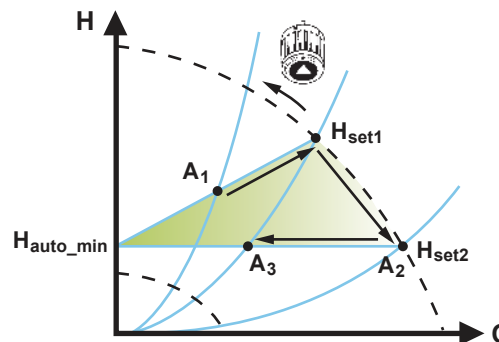

TM052452

### AUTOADAPT control

A <sub>1</sub> :	Original duty point.
A <sub>2</sub> :	Lower registered head on the maximum curve.
A <sub>3</sub> :	New duty point after AUTOADAPT control.
H <sub>set1</sub> :	Original setpoint setting.
H <sub>set2</sub> :	New setpoint after AUTOADAPT control.
H <sub>fac</sub> :	See section Flow estimation accuracy.
H <sub>auto_min</sub> :	A fixed value of 1.5 m.

The AUTOADAPT control mode is a form of proportional-pressure control where the control curves have a fixed origin, H<sub>auto\_min</sub>.

When you have enabled AUTOADAPT, the pump will start with the factory setting, H<sub>fac</sub> = H<sub>set1</sub>, corresponding to approx. 55 % of its maximum head, and then adjust its performance to A<sub>1</sub>. See figure above.

When the pump registers a lower head on the maximum curve, A<sub>2</sub>, the AUTOADAPT function automatically selects a correspondingly lower control curve, H<sub>set2</sub>. If the valves in the system close, the pump adjusts its performance to A<sub>3</sub>. See figure above.



Manual setting of the setpoint is not possible.

### Related information

[8.6 Flow estimation accuracy](#)

TM079207

### 8.3.3 FLOWADAPT

The FLOWADAPT control mode combines AUTOADAPT and FLOWLIMIT, meaning that the pump runs AUTOADAPT while at the same time ensuring that the flow never exceeds the entered FLOWLIMIT value. This control mode is suitable for systems where a maximum flow limit is desired and where a steady flow through the boiler in a boiler system is required. Here, no extra energy is used for pumping too much liquid into the system.

In systems with mixing loops, you can use FLOWADAPT to control the flow in each loop.

#### Characteristics and key benefits

- The dimensioned flow for each zone (required heat energy) is determined by the flow from the pump. This flow can be set precisely in the FLOWADAPT control mode without using throttling valves.
- When the flow is set lower than the balancing valve setting, the pump will ramp down instead of losing energy by pumping against a balancing valve.
- Cooling surfaces in air-conditioning systems can operate at high pressure and low flow.

**Note:** The pump cannot reduce the flow on the inlet side, but is able to control that the flow on the outlet side is at least the same as on the inlet side. This is due to the fact that the pump has no built-in valve.

#### Technical specifications

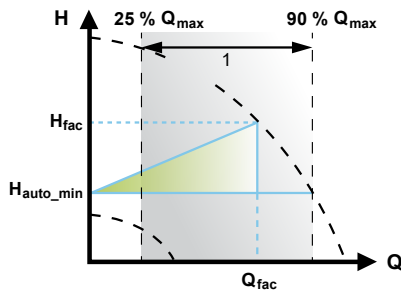

TM053334

FLOWADAPT control

Pos.	Description
1	Setting range

The factory setting of the FLOWADAPT is the flow where the AUTOADAPT factory setting meets the maximum curve. See figure above.

The typical pump selection is based on the required flow and calculated pressure losses. The pump is typically oversized by 30 to 40 % to ensure that it can overcome the pressure losses in the system. Under these conditions, the full benefit of AUTOADAPT cannot be obtained.

To adjust the maximum flow of this "oversized" pump, balancing valves are built into the circuit to increase the resistance and thus reduce the flow.

The FLOWADAPT function reduces the need for a pump throttling valve, see figure below, but does not eliminate the need for balancing valves in heating systems.

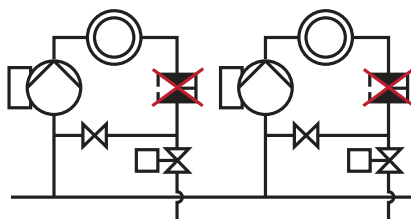

TM052685

Reduced need for a pump throttling valve

### 8.3.4 Proportional pressure

Proportional pressure is suitable in systems with relatively large pressure losses in the distribution pipes and in air-conditioning and cooling systems:

- Two-pipe heating systems with thermostatic valves and the following:
  - very long distribution pipes
  - strongly throttled pipe-balancing valves
  - differential-pressure regulators
  - large pressure losses in those parts of the system where the total quantity of water flows, for example a boiler, heat exchanger and distribution pipe up to the first branching.
- Primary circuit pumps in systems with large pressure losses in the primary circuit.
- Air-conditioning systems with the following:
  - heat exchangers (fan coils)
  - cooling ceilings
  - cooling surfaces.

#### Characteristics and key benefits

- The head of the pump increases proportionally to the flow in the system.
- Compensates for large pressure losses in the distribution pipes.

#### Technical specifications

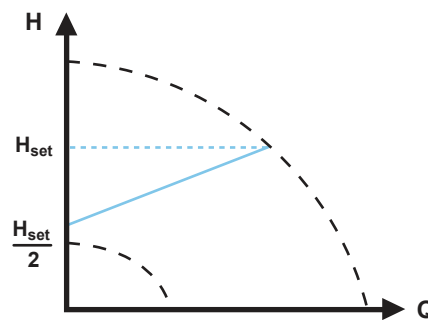

TM052448

Proportional-pressure control

The head is reduced at decreasing flow demand and increased at rising flow demand.

The head against a closed valve is half the setpoint  $H_{set}$ . You can set the setpoint with an accuracy of 0.1 metre.

### 8.3.5 Constant pressure

A constant pressure is advantageous in systems with relatively small pressure losses in the distribution pipes:

- Two-pipe heating systems with thermostatic valves:
  - dimensioned for natural circulation
  - small pressure losses in those parts of the system where the total quantity of water flows, for example a boiler, heat exchanger and distribution pipe up to the first branching
  - modified to a high differential temperature between flow pipe and return pipe, for example district heating.
- Underfloor heating systems with thermostatic valves.
- One-pipe heating systems with thermostatic valves or pipe-balancing valves.
- Primary circuit pumps in systems with small pressure losses in the primary circuit.

#### Characteristics and key benefits

- The pump pressure is kept constant, independent of the flow in the system.

#### Technical specifications

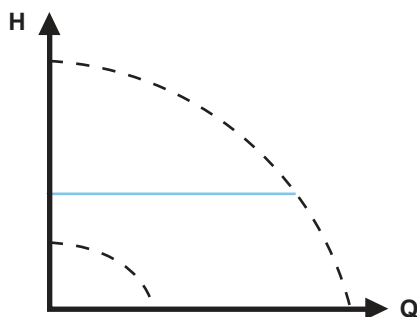

TM052449

Constant-pressure control

### 8.3.6 Constant temperature

This control mode is suitable in systems with a fixed system characteristic, for example domestic hot-water systems, where control of the pump according to a constant return-pipe temperature is relevant.

The pump is from factory set to operate in a heating system with a controller gain,  $K_p$ , equal to 1. If the pump operates in a cooling system, the gain must be changed to a negative value, for example -1. See section "Controller settings" (not model A).

#### Characteristics and key benefits

- The temperature is kept constant.
- Use FLOW *LIMIT* to control the maximum circulation flow.

#### Technical specifications

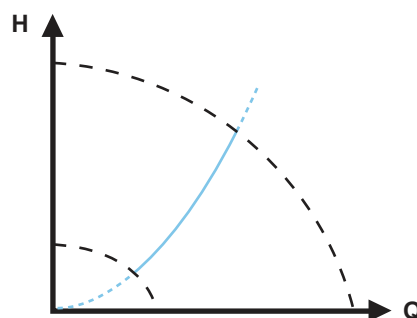

TM052451

Constant-temperature control

When you use this control mode, do not install any balancing valves in the system.

The inverse control for cooling application is available from model B.

#### Temperature sensor

If the pump is installed in the flow pipe, install an external temperature sensor in the return pipe of the system. See figure below. Install the sensor as close as possible to the consumer (radiator, heat exchanger, etc.).

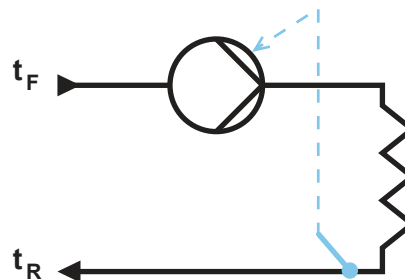

TM052615

Pump with an external sensor

We recommend that you install the pump in the flow pipe.

If the pump is installed in the return pipe of the system, you can use the internal temperature sensor. In this case, install the pump as close as possible to the consumer (radiator, heat exchanger, etc.).

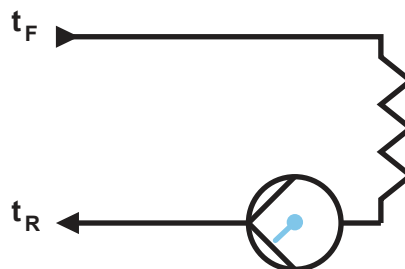

TM052616

Pump with the internal sensor

Sensor range:

- minimum +14 °F (-10 °C)
- maximum +266 °F (+130 °C)

To ensure that the pump is able to control the temperature, we recommend that you set the sensor range between +23 and +257 °F (-5 and +125 °C).

#### Related information

[9.7.4 "Controller settings" \(not model A\)](#)

### 8.3.7 Differential temperature

Select this control mode if the pump performance is to be controlled according to a differential temperature in the system where the pump is installed.

#### Characteristics and key benefits

- Ensures a constant differential temperature drop across heating and cooling systems.
- Ensures a constant differential temperature between the pump and the external sensor, see figures below.
- Requires two temperature sensors, the internal temperature sensor together with an external sensor.

**Technical specifications**

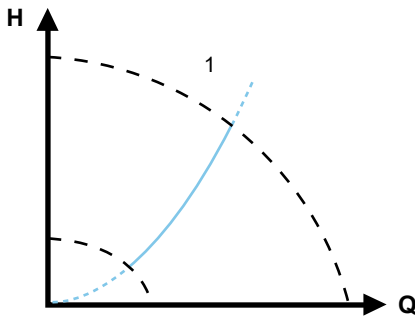

TM052451

*Differential temperature*

Pos.	Description
1	$\Delta t$

**Temperature sensor**

To measure the temperature difference of the flow and return pipe, you must use both the internal sensor and an external sensor. If the pump is installed in the flow pipe, the external sensor must be installed in the return pipe and vice versa. Always install the sensor as close as possible to the consumer (radiator, heat exchanger, etc.). See figure below.

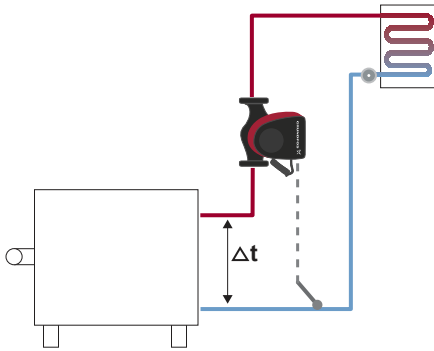

TM058236

*Differential temperature*

**8.3.8 Constant flow**

**Note:** Available for pumps with production code from 1838. The pump maintains a constant flow in the system independently of the head. See figure below. Constant flow is suitable in applications such as air handling units, hot-water systems and ground-source heating systems.

**Characteristics and key benefits**

- It is not possible to use an external sensor, instead, the pump uses its internal sensor.
- In multipump systems constant flow is only available in alternating and backup operation, not cascade operation.

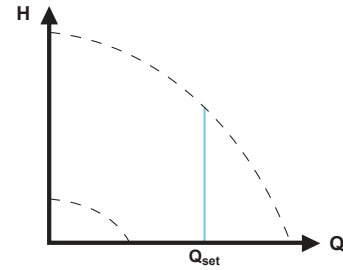

TM071240

*Constant flow rate*

**8.3.9 Constant curve**

A constant curve is suitable for systems where there is a demand for both constant flow and constant head, i.e.:

- heating surfaces
- cooling surfaces
- heating systems with 3-way valves
- air-conditioning systems with 3-way valves
- chiller pumps.

**Characteristics and key benefits**

- If an external controller is installed, the pump is able to change from one constant curve to another, depending on the value of the external signal.
- Depending on your preferences, the pump can be controlled according to either a maximum or minimum curve.

**Technical specifications**

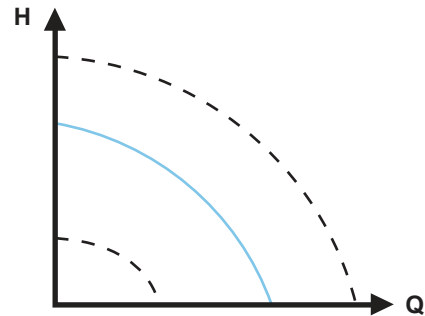

TM052446

*Constant-curve mode*

The pump can be set to operate according to a constant curve, like an uncontrolled pump. See figure above. Depending on the pump model, you can set the desired speed in % of the maximum speed. The span of control depends on the minimum speed, power and pressure limitation of the pump.

If the pump speed is set in the range between minimum and maximum, the power and pressure are limited when the pump is running on the maximum curve. This means that the maximum performance can be achieved at a speed lower than 100 %. See figure below.

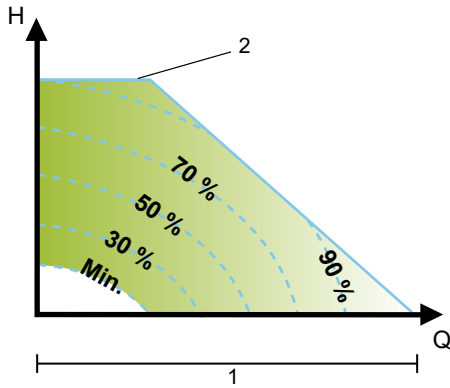

TM056242

Power and pressure limitations influencing the maximum curve

Pos.	Description
1	Limited max. curve
2	Speed setting from 0 to 100 %

You can also set the pump to operate according to the maximum or minimum curve, like an uncontrolled pump:

- You can use the maximum curve mode in periods in which a maximum flow is required. This operating mode is for instance suitable for hot-water priority.
- You can use the minimum curve mode in periods in which a minimum flow is required. This operating mode is for instance suitable for manual night setback if automatic night setback is not desired.

You can select these two operating modes via the digital inputs.

In the control mode constant curve, you can obtain constant flow by choosing a setpoint at 100 % and choosing the desired value for the flow with the flow limit function  $FLOW_{LIMIT}$ . Take the accuracy of the flow estimation into consideration.

### 8.4 Additional control mode features

MAGNA3 offers additional features for the control modes to meet specific demands.

#### 8.4.1 FLOWLIMIT

The feature is an integrated part of the FLOWADAPT control mode, but can also be used in:

- proportional-pressure mode
- constant-pressure mode
- constant-temperature mode
- constant-curve mode
- differential-temperature mode.

#### Characteristics and key benefits

- A control mode feature that, when activated, ensures that the rated maximum flow is never exceeded.

By enabling FLOWLIMIT in systems where MAGNA3 has full authority, the rated flow is never exceeded, thus eliminating the need for throttling valves.

#### Technical specifications

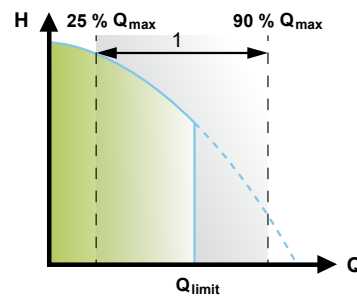

TM052445

#### $FLOW_{LIMIT}$

Pos.	Description
1	Setting range

The factory setting of the FLOWLIMIT is the flow where the AUTOADAPT factory setting meets the maximum curve.

The setting range for the FLOWLIMIT is 25 to 90 % of the  $Q_{max}$  of the pump. Do not set the FLOWLIMIT lower than the dimensioned duty point.

In the flow range between 0 and  $Q_{limit}$ , the pump will run according to the selected control mode. When  $Q_{limit}$  is reached, the FLOWLIMIT function will reduce the pump speed to ensure that the flow never exceeds the FLOWLIMIT set, no matter if the system requires a higher flow due to increased resistance in the system.

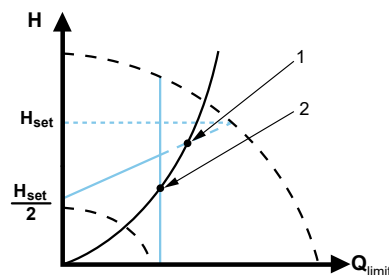

TM052543

#### Proportional-pressure control with FLOWLIMIT

Pos.	Description
1	Normal proportional-pressure duty point
2	FLOWLIMIT duty point

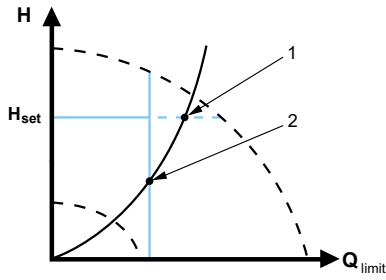

TM052544

Constant-pressure control with FLOWLIMIT

Pos.	Description
1	Normal constant-pressure duty point
2	FLOWLIMIT duty point

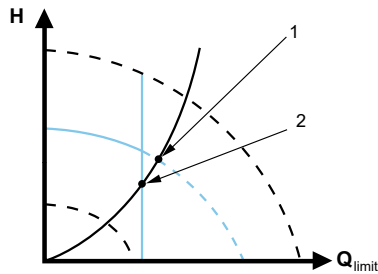

TM052542

Constant curve with FLOWLIMIT

Pos.	Description
1	Normal constant-curve duty point
2	FLOWLIMIT duty point

### 8.4.2 Automatic night setback

A night setback system is often integrated into a building management system (BMS), or as part of an equivalent electronic control system, which has a built-in timer.

The feature is not beneficial in a room that has underfloor heating because of the regulating inertia of the underfloor heating.

#### Characteristics and key benefits

- Automatic night setback lowers the room temperature at night, which reduces heating costs.
- The pump automatically changes between normal duty and night setback (duty at low demand) depending on the flow pipe temperature.
- Once activated, the pump runs on the minimum curve.

#### Technical specifications

The pump automatically changes to night setback when the built-in sensor registers a flow-pipe temperature drop of more than 18 to 27 °F (10 to 15 °C) within approximately two hours. The temperature drop must be at least 0.18 °F/min (0.1 °C/min).

Changeover to normal duty takes place without time lag when the temperature has increased by approximately 18 °F (10 °C).



You cannot enable automatic night setback when the pump is in constant-curve mode.

## 8.5 Multipump modes

### 8.5.1 Multipump function

The multipump function enables the control of single-head pumps connected in parallel and twin-head pumps without the use of external controllers. The pump is designed for multipump connection via the wireless GENlair connection. The built-in wireless GENlair module enables communication between pumps and with Grundfos GO without the use of add-on modules. See sections Servicing the product and Grundfos GO .

Pump system:

- Twin-head pump.
- Two single-head pumps connected in parallel. The pumps must be of equal size and type. Each pump requires a check valve in series with the pump.

A multipump system is set via a selected pump, i.e. the master pump (first selected pump). The multipump functions are described in the following sections.

Configuration of twin-head pumps is described in section Twin-head pump.

For information about input and output communication in a multipump system, see section External connections in a multipump system.

#### Related information

[5.2 Twin-head pump](#)

[8.9.1 External connections in a multipump system](#)

[10. Servicing the product](#)

[12.1 Grundfos GO](#)

### 8.5.2 Alternating operation

Only one pump is operating at a time. The change from one pump to the other depends on time or energy. If a pump fails, the other pump will take over automatically.

### 8.5.3 Backup operation

One pump is operating continuously. The backup pump is operating at intervals to prevent seizing up. If the duty pump stops due to a fault, the backup pump will start automatically.

### 8.5.4 Cascade operation

Cascade operation ensures that the pump performance is automatically adapted to the consumption by switching pumps on or off. The system thus runs as energy-efficiently as possible with a constant pressure and a limited number of pumps.

The slave pump will start when the master pump either runs at 90 % of the maximum speed or runs on the maximum curve.

The slave pump stops if one of the following conditions are fulfilled:

- One of the two pumps runs on minimum curve.
- One of the two pumps runs below 50 % of the maximum speed and at the same time runs below 50 % of the maximum power consumption.

Cascade operation is available in constant speed and constant pressure. You can with advantage choose a twin-head pump, as the backup pump will start for a short period in peak-load situations.

All pumps in operation will run at equal speed. Pump changeover is automatic and depends on speed, operating hours and faults.

## 8.6 Flow estimation accuracy

The internal sensor estimates the difference in pressure between the inlet and outlet ports of the pump. The measurement is not a direct differential-pressure measurement, but by knowing the hydraulic design of the pump, you can estimate the differential pressure across the pump. The speed and power give a direct estimation of the actual duty point at which the pump is running.

The calculated flow rate has a typical accuracy of  $\pm 5\%$  of  $Q_{max}$ . The less flow through the pump, the less accurate the reading will be. In worst case scenarios, such as closed valve operation, the accuracy can be up to 10 % of  $Q_{max}$ .

See also section Heat energy monitor.

Example:

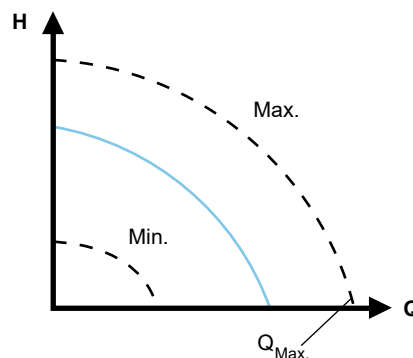

$Q_{max}$

1. MAGNA3 65-60 has a  $Q_{max}$  of 40 m<sup>3</sup>/h. Typically 5 % accuracy means 2 m<sup>3</sup>/h inaccuracy of  $Q_{max} \pm 2$  m<sup>3</sup>/h.
2. This accuracy is valid for the entire QH area. If the pump indicates 10 m<sup>3</sup>/h, the measurement is  $10 \pm 2$  m<sup>3</sup>/h.
3. The flow rate can be from 8-12 m<sup>3</sup>/h.

The use of a mixture of water and ethylene-glycol will reduce the accuracy.

If the flow is less than 10 % of  $Q_{max}$ , the display shows a low flow. See section External connections, for flow accuracy calculations of the complete MAGNA3 range.

#### Related information

[8.7 External connections](#)

[8.9.5 Heat energy monitor](#)

TM081473

### 8.7 External connections

#### WARNING

##### Electric shock



Minor or moderate personal injury

- Separate wires connected to supply terminals, outputs NC, NO, C and start-stop input from each other and from the supply by reinforced insulation.

Make sure that all cables are heat-resistant up to 158 °F (70 °C).



Install all cables in accordance with the National Electrical Code, or in Canada, the Canadian Electrical Code, and state and local regulations.



Connect all cables in accordance with local regulations.

Concerning demands on signal wires and signal transmitters, see section Disposing of the product.

Use screened cables for external on-off switch, digital input, sensor and setpoint signals.

Connect screened cables to the ground connection as follows:

- Terminal-connected versions:  
Connect the cable screen to ground via the digital-input terminal. See figure below.

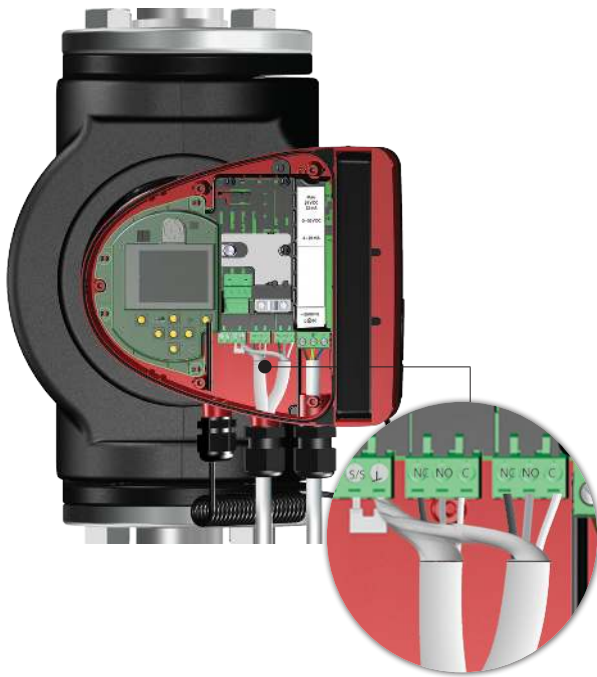

Connection of cable screen

TM056060

- Wire-to-wire-connected versions:  
Connect the cable screen to ground via cable clamp. See figure below.

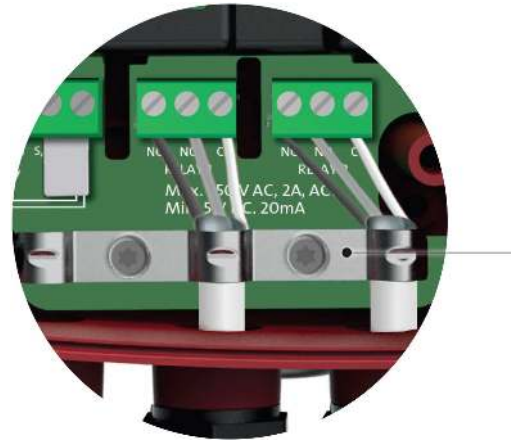

TM071681

Cable clamp

Pos.	Description
1	Cable clamp

#### Related information

[14. Disposing of the product](#)

### 8.8 Priority of settings

The external forced-control signals influence the settings available on the pump operating panel or with Grundfos GO. However, you can always set the pump to maximum-curve duty or stop the pump on the operating panel or with Grundfos GO.

If two or more functions are enabled at the same time, the pump operates according to the setting with the highest priority.

The priority of the settings is as shown in the table below.

**Example:** If the pump has been forced to stop via an external signal, the operating panel or Grundfos GO can only set the pump to maximum curve.

Priority	Possible settings		
	Operating panel or Grundfos GO	External signals	Bus signal
1	"Stop"		
2	"Max. curve"		
3		"Stop"	
4			"Stop"
5			"Max. curve"
6			"Min. curve"
7			"Start"
8		"Max. curve"	
9	"Min. curve"		
10		"Min. curve"	
11	"Start"		

## 8.9 Input and output communication

- Relay outputs
  - Alarm, ready and operating indication via signal relay.
- Digital input
  - Start and stop (S/S)
  - Minimum curve (MI)
  - Maximum curve (MA).
- Analog input
  - 0-10 V or 4-20 mA control signal.
  - To be used for external control of the pump or as sensor input for the control of the external setpoint.
  - The 24-V supply from pump to sensor is optional and is normally used when an external supply is not available.

### WARNING



#### Electric shock

Death or serious personal injury

- Separate input voltages from external equipment from live parts by reinforced insulation.

### 8.9.1 External connections in a multipump system

The following external connections need only to be fitted to the master pump:

- analog input
- digital input
- communication interface module, CIM
  - If you want to monitor a slave pump, mount a communication interface module on the slave pump too.

The following external connections need to be fitted on both the master and slave pumps:

- Relays (from model B)

The following are system parameters shared between the pumps:

- Operating mode, control mode and setpoint
- Heat energy monitor:
  - Both pumps display the heat energy for the entire system and not only for the individual pump. Please note that all calculations are made in the master pump. If the master pump loses power, the heat energy will cease to increment. See also section Heat energy monitor.

For more information about input and output communication in multipump systems, see sections Relay outputs, Digital inputs and Analog input.

#### Related information

- [\[TOPIC NOT IN MAP \(empty topicContent\)\]](#)  
*href=reference-LBkpiX7.dita*
- [\[TOPIC NOT IN MAP \(empty topicContent\)\]](#)  
*href=reference-OZc9U11.dita*
- [\[TOPIC NOT IN MAP \(empty topicContent\)\]](#)  
*href=reference-WtvxQoP.dita*
- [\[TOPIC NOT IN MAP \(empty topicContent\)\]](#)  
*href=concept-vf5MPqk.dita*
- [\[TOPIC NOT IN MAP \(empty topicContent\)\]](#)  
*href=reference-LBkpiX7.dita*
- [\[TOPIC NOT IN MAP \(empty topicContent\)\]](#)  
*href=reference-OZc9U11.dita*
- [\[TOPIC NOT IN MAP \(empty topicContent\)\]](#)  
*href=reference-WtvxQoP.dita*
- [\[TOPIC NOT IN MAP \(empty topicContent\)\]](#)  
*href=concept-vf5MPqk.dita*

#### 8.9.3 Digital inputs

#### 8.9.4 Analog input

#### 8.9.2 Relay outputs

#### 8.9.5 Heat energy monitor

### 8.9.2 Relay outputs

The pump has two signal relays with a potential-free changeover contact for external fault indication.

The two signal relays are protected by a relay cover. To access the relays, you must remove the cover by unscrewing the screw located at the top of the cover. See figure below.

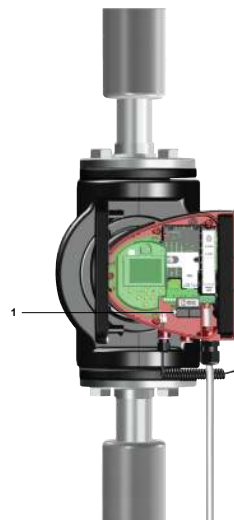

TM079208

Removing the relay cover

Pos.	Description
1	Relay cover

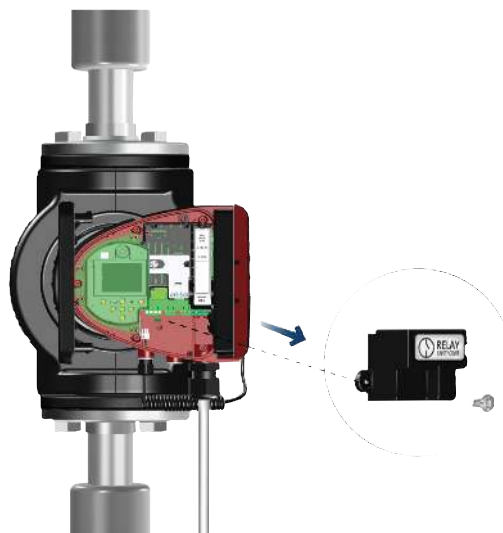

TM076458

Removing the relay cover

You can set the function of the signal relay to "**Alarm**", "**Ready**" or "**Operation**" on the operating panel or with Grundfos GO.

The relays can be used for outputs up to 250 V and 2 A.



Warnings do not activate the alarm relay.



Use C and NC for fault signals as this enables serial connections of more relays and detection of signal cable defects.

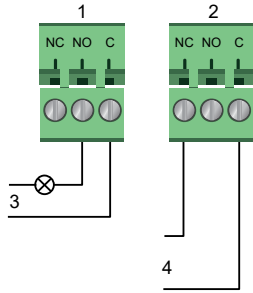

TM053338

*Relay output*

Pos.	Description
1	Relay 1
2	Relay 2
3	Operation
4	Alarm

Contact symbol	Function
NC	Normally closed
NO	Normally open
C	Common

The functions of the signal relays appear from the table below:

Signal relay	Alarm signal
	<p>Not activated:</p> <ul style="list-style-type: none"> <li>The power supply has been switched off.</li> <li>The pump has not registered a fault.</li> </ul>
	<p>Activated:</p> <ul style="list-style-type: none"> <li>The pump has registered a fault.</li> </ul>
Signal relay	Ready signal
	<p>Not activated:</p> <ul style="list-style-type: none"> <li>The pump has registered a fault and is unable to run.</li> <li>The power supply has been switched off.</li> </ul>
	<p>Activated:</p> <ul style="list-style-type: none"> <li>The pump has been set to stop, but is ready to run.</li> <li>The pump is running.</li> </ul>
Signal relay	Operating signal
	<p>Not activated:</p> <ul style="list-style-type: none"> <li>The power supply has been switched off.</li> </ul>
	<p>Activated:</p> <ul style="list-style-type: none"> <li>The pump is running.</li> </ul>

Factory settings of relays:

Relay	Function
1	Operating signal
2	Alarm signal

**Relay output in twin-head pumps**

The relay output for both the "**Alarm**", "**Ready**" and "**Operation**" functions operates independently on each pump head. If, for example, a fault occurs in one of the pumps, its respective relay is triggered.

### 8.9.3 Digital inputs

You can use the digital input for external control of start-stop or forced maximum or minimum curve.

If no external on-off switch is connected, the jumper between terminals start-stop (S/S) and frame ( $\downarrow$ ) must be maintained. This connection is the factory setting.

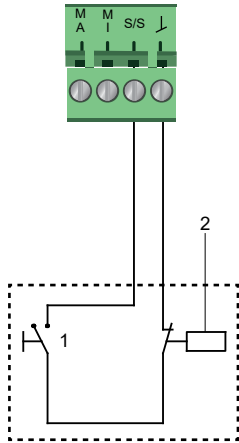

TM053339

Digital input

Pos.	Description
1	Start-stop
2	On-off timer

Contact symbol	Function
M	Maximum curve
A	100 % speed
M	Minimum curve
I	Minimum curve
S/S	Start-stop
$\downarrow$	Frame connection

### External start-stop

You can start and stop the pump via the digital input.

Start-stop	
	<p>Normal duty Factory setting with jumper between start-stop and <math>\downarrow</math>.</p>
	<p>Stop</p>

### Externally forced maximum or minimum curve

You can force the pump to operate on the maximum or minimum curve via the digital input.

Maximum curve	
	<p>Normal duty</p>
	<p>Maximum curve</p>
Minimum curve	
	<p>Normal duty</p>
	<p>Minimum curve</p>

Select the function of the digital input using the pump's operating panel or Grundfos GO.

### Digital input on twin-head pumps

The Start/Stop input operates on system level, meaning that if the master pump head receives a stop signal, the system stops.

As a main rule, the digital input is only effective on the master, which is why it is important to know which pump is assigned as master, see figure below.

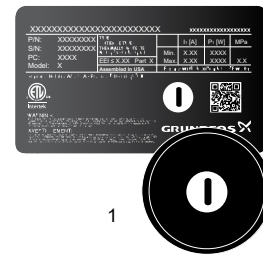

TM069088

### Identifying the master pump head on the nameplate

Pos.	Description
1	I is defined as master.

For redundancy purposes, the digital input can be used concurrently on the slave pump head. However, as long as the master is powered up, the input on the slave will be ignored. In the event of power loss on the master, the digital input of the slave will take over. When the master pump head is back on, the master takes over and controls the system.

### 8.9.4 Analog input

You can use the analog input for the connection of an external sensor for measuring temperature or pressure.

You can use sensor types with 0-10 V or 4-20 mA signal.

You can also use the analog input for an external signal for the control from a building management system or similar control system.

- When the input is used for the heat energy monitor, install a temperature sensor in the return pipe.
- If the pump is installed in the return pipe of the system, install the sensor in the flow pipe.
- If the constant-temperature control mode has been enabled and the pump is installed in the flow pipe of the system, install the sensor in the return pipe.
- If the pump is installed in the return pipe of the system, you can use the internal temperature sensor.

You can change the sensor type, 0-10 V or 4-20 mA, on the operating panel or with Grundfos GO.

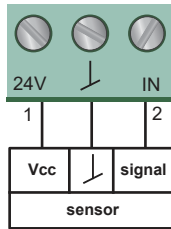

Analog input for external sensor, 0-10 V

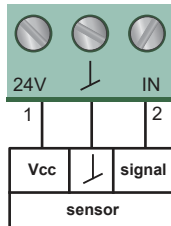

Analog input for external sensor, 4-20 mA

Pos.	Description
1	Vcc
2	Signal

To optimize pump performance, you can use the analog input for the connection of an external sensor in the following cases:

Function/control mode	Sensor type
Heat energy monitor	
Constant temperature	Temperature sensor
Differential temperature	
Constant pressure	Differential-pressure transmitter



When using a differential-pressure transmitter to control the flow, make sure that the pump is set to run in constant-pressure mode and that "Differential-pressure control" has been activated in the "Analog input" menu on the pump's operating panel. See section "Analog Input".

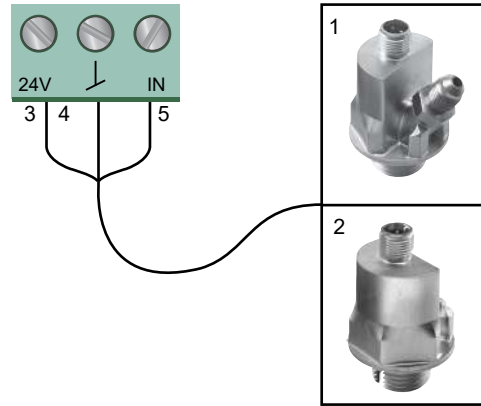

Examples of external sensors

Pos.	Description
1	Combined temperature and pressure sensor, Grundfos type RPI T2. 1/2" connection and 0-10 V signal
2	Pressure sensor, Grundfos type RPI. 1/2" connection and 4-20 mA signal.
3	Vcc
4	↓
5	Signal

For further details, see section External sensors.

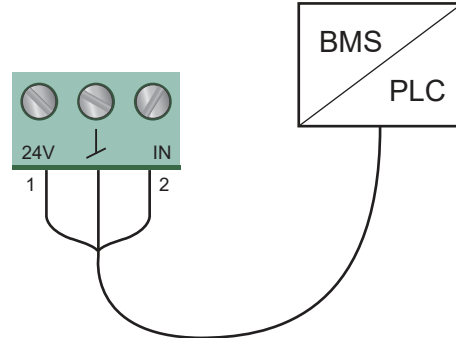

Examples of external signal for the control via BMS or PLC

#### Analog input on twin-head pumps

For redundancy purposes, the analog input can be used concurrently on the slave pump head. As long as the master is powered up, the input on the slave will be ignored. However, in the event of power loss on the master, the analog input of the slave will take over. When the master pump head is back on, the master takes over and controls the system.

#### Related information

[9.7.6 "Analog Input"](#)

[12.4.1 Temperature sensor](#)

### 8.9.5 Heat energy monitor

The heat energy monitor calculates the heat energy consumption within the system. The built-in flow estimation needed for the calculation has a typical accuracy of  $\pm 5\%$  of  $Q_{max}$ . The less flow through the pump, the less accurate the reading will be. In worst case scenarios, such as closed valve operation, the accuracy can be up to  $10\%$  of  $Q_{max}$ . The actual accuracy in a duty point will be shown in the MAGNA3 display (available for pumps with production code from 1838). The temperature measurement accuracy also depends on the sensor type. Therefore, you cannot use the heat energy value for billing purposes. However, the value is perfect for optimization purposes in order to prevent excessive energy costs. See also section Flow estimation accuracy.

To counterbalance any inaccuracy on either the internal and external sensor it is possible to manually enter a temperature offset. The offset is entered in integers, for example 2 degrees. The offset range is within  $\pm 36\text{ }^{\circ}\text{F}$  ( $\pm 20\text{ }^{\circ}\text{C}$ ). To set the temperature offset, see section "Controller settings" (not model A).

Note: Temperature sensor offset is available for pumps with production code from 1838.

The flow and volume accuracy is calculated and shown in the display, see sections "Heat energy monitor".



The heat energy monitor requires an additional temperature sensor installed in the flow pipe or return pipe depending on where the pump is installed.

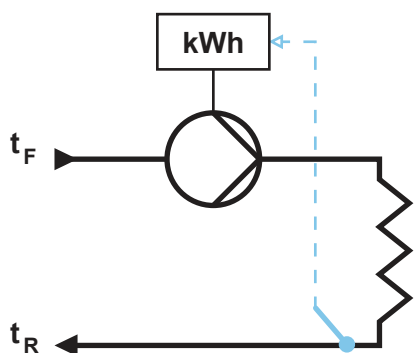

MAGNA3 with built-in heat energy monitor

You can measure both heating and cooling in the same system. If a system is used for both heating and cooling, two counters are automatically shown in the display. See section "Heat energy monitor".

### Monitoring heat energy in multipump systems

In a multipump system, the master pump calculates the heat energy regardless of which pump, master or slave, is running.

If the master loses power or has a fault on the external sensor, the accumulation of heat energy will not be counted until the master is powered back on or the external sensor error is remedied. If the master is replaced, the heat energy values for the system is reset.

### Related information

[8.6 Flow estimation accuracy](#)

[9.6.1 "Heat energy monitor"](#)

[9.7.4 "Controller settings" \(not model A\)](#)

### 8.9.6 External setpoint function

You can use the analog input to influence the setpoint externally.

The external setpoint function can be used in two different ways:

- "Linear with Min."
- "Linear with Stop" (available for pumps with production code from 1838)

In both modes the input signal range is influenced linearly.

#### "Linear with Min."

Here, a 0-10 V or 4-20 mA signal controls the pump speed range in a linear function. The range of control depends on the minimum speed, power and pressure limits of the pump. See figures below.

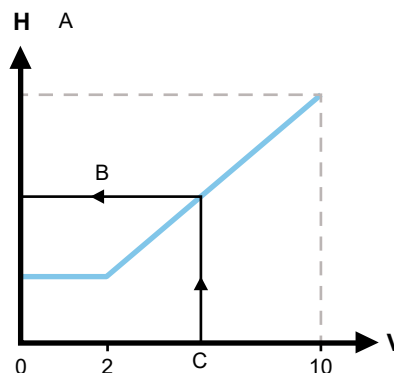

TM069149

External setpoint function, 0-10 V

Pos.	Description
A	(user setpoint)
B	Resulting setpoint
C	Analog input

Control	
0-2 V (0-20 %)	Resulting setpoint is equal to minimum.
2-10 V (20-100 %)	Resulting setpoint is between minimum and user setpoint.

#### Control range and setpoint

The external setpoint function operates differently depending on the model. For models A, B and C, the maximum speed is often obtained at voltages lower than 10 V, as the span of control is limited.

In models newer than A, B and C, the internal scaling has been optimized making the dynamic area bigger, thus giving a better control of the pump speed when using the external setpoint function.

The same applies if the pump is receiving a setpoint from Building Management Systems.

**"Linear with Stop"**

**Note:** Available for pumps with production code from 1838.  
 Here, if the input signal is below 10 %, the pump changes to operating mode **"Stop"**. If the input signal is increased above 15 %, the operating mode is changed back to **"Normal"**.

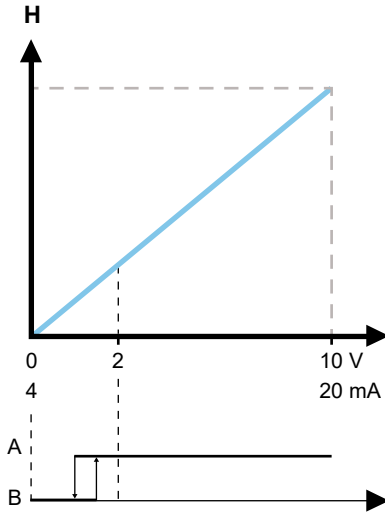

TM071250

**"Linear with Stop", 0-10 V**

Pos.	Description
A	Normal
B	Stop

**9. Setting the product**

**CAUTION**

**Hot surface**

Minor or moderate personal injury



- At high liquid temperatures, the pump housing may be so hot that only the operating panel may be touched to avoid burns.

**9.1 Operating panel**



TM053820

*Operating panel*

Button	Function
	Goes to the <b>"Home"</b> menu.
	Bluetooth connect button.
	Navigates between main menus, displays and digits. When the menu is changed, the display always shows the top display of the new menu.
	Navigates between submenus.
	Saves changed values, resets alarms and expands the value field.

## 9.2 Menu structure

The pump incorporates a startup guide which is started at the first startup. After the startup guide, the four main menus appear in the display. See section Control functions.

### "Home"

This menu shows up to four user-defined parameters with shortcuts or a graphical illustration of a performance curve. See section "Home" menu.

### "Status"

This menu shows the status of the pump and system as well as warnings and alarms. See section "Status" menu.



You cannot make settings in this menu.

### "Settings "

This menu gives access to all setting parameters. You can make a detailed setting of the pump in this menu. See section "Settings" menu.

### "Assist"

This menu enables assisted pump setup, provides a short description of the control modes and offers fault advice. See section "Assist" menu.

- Shortcut to control mode settings
- Shortcut to setpoint settings
- **"Estimated flow"**
- **"Head"**.

#### Related information

[8.1 Quick overview of control modes](#)

[9.5 "Home" menu](#)

[9.6 Status menu](#)

[9.7 "Settings" menu](#)

[9.8 "Assist" menu](#)

## 9.3 Startup guide

At first startup you are asked to choose a language after which a startup guide helps you set the date and time.

Follow the instructions given by the display and use the arrows to navigate.

### 9.3.1 "Multipump pairing", twin-head pumps

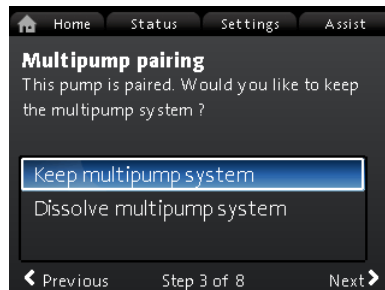

**Note:** Available for pumps with production code from 1838.

Twin-head pumps are paired from factory. When starting up a twin-head pump for the first time, the startup guide will ask whether or not to keep the multipump system enabled.

#### Setting

1. Select **"Keep multipump system"** or **"Dissolve multipump system"** with  $\downarrow$  or  $\uparrow$ .
2. Press [OK] followed by  $\rightarrow$ .
3. Press [OK] to confirm.

The multipump system can be reestablished in the **"Assist"** menu. See section "Multipump setup".

#### Related information

- [TOPIC NOT IN MAP (empty topicContent)]

href=task-g50ZZym.dita

- [TOPIC NOT IN MAP (empty topicContent)]

href=task-g50ZZym.dita

[9.8.3 "Multipump setup"](#)

### 9.3.2 "Setting of pump"

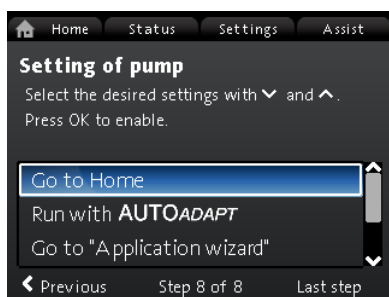

Startup guide: Setting of the pump

#### "Run with AUTOADAPT"

If you choose "Run with AUTOADAPT", the pump operates according to its factory settings. See section Factory setting.

#### "Go to "Application wizard""

**Note:** Available for pumps with production code from 1838.

The "Application wizard" helps you choose the correct control mode for your application and includes the following:

- **Boiler pump**
- **Radiator**
- **Fan coil unit**
- **Air handling unit**
- **Underfloor/ceiling**
- **Hot water**
- **Ground source**
- **Chiller pump.**

You can exit the wizard by pressing the "Home" button .

You can also launch the wizard in the "Assist" menu. See section "Application wizard".

#### "External speed control"

**Note:** Available for pumps with production code from 1838.

When selecting the "External speed control", you can choose between the following:

- **"0-10 V input" and "4-20 mA input"**  
Allows you to select either "Linear with Min." or "Linear with Stop". See also section External setpoint function..
- **"Bus controlled"**  
When selected and when the startup guide has completed, go to the "Settings" menu to configure the "Bus communication". See section "Bus communication".

#### Related information

- [\[TOPIC NOT IN MAP \(empty topicContent\)\]](#)  
[href=concept-UKmIK3r.dita](concept-UKmIK3r.dita)
- [\[TOPIC NOT IN MAP \(empty topicContent\)\]](#)  
[href=concept-vyuCkLW.dita](concept-vyuCkLW.dita)
- [\[TOPIC NOT IN MAP \(empty topicRef\)\]](#)  
[href=task-xzjURgc.dita](task-xzjURgc.dita)
- [\[TOPIC NOT IN MAP \(empty topicContent\)\]](#)  
[href=concept-UKmIK3r.dita](concept-UKmIK3r.dita)
- [\[TOPIC NOT IN MAP \(empty topicContent\)\]](#)  
[href=concept-vyuCkLW.dita](concept-vyuCkLW.dita)
- [\[TOPIC NOT IN MAP \(empty topicRef\)\]](#)  
[href=task-xzjURgc.dita](task-xzjURgc.dita)

#### [8.3.1 Factory setting](#)

#### [8.9.6 External setpoint function](#)

#### [9.7.10 "Bus communication"](#)

#### [9.8.1 "Application wizard"](#)

#### [9.8.1 "Application wizard"](#)

#### [9.8.1 "Application wizard"](#)

## 9.4 Menu overview

"Home"	Status	"Settings"	"Assist"
Control mode	Operating status	Setpoint	Application wizard <sup>1)</sup>
Setpoint	Operating mode, from	Operating mode	Boiler pump
Estimated flow	Control mode	Normal	Radiator
Low flow <sup>1) 2)</sup>	Pump performance	Stop	Fan coil unit
Head	Max. curve and duty point	Min.	Air handling unit
	Resulting setpoint	Max.	Underfloor/ceiling
	Temperature	Control mode	Hot water
	Speed	AUTOADAPT	Ground source
	Operating hours	FLOWADAPT	Chiller pump
	Power and energy consumption	Prop. press.	Setting of date and time
	Power consumption	Const. press.	Date format, date and time
	Energy consumpt.	Const. temp.	Date only
	Warning and alarm	Diff. temp.	Time only
	Actual warning or alarm	Constant flow <sup>1)</sup>	Multipump setup
	Warning log	Constant curve	Setup, analog input
	Warning log 1 to 5	Controller settings (not model A)	Description of control mode
	Alarm log	Controller gain Kp	AUTOADAPT
	Alarm log 1 to 5	Control. integr. action time Ti	FLOWADAPT
	Heat energy monitor	Temperature sensor offset <sup>1)</sup>	Prop. press.
	Heat power	FLOWLIMIT	Const. press.
	Heat energy	Enable FLOWLIMIT function	Const. temp.
	Estimated flow	Not active	Differential temp.
	Volume	Active	Constant curve
	Hours counter	Set FLOWLIMIT	Assisted fault advice
	Temperature 1	Automatic Night Setback	Blocked pump
	Temperature 2	Not active	Pump communication fault
	Differential temp.	Active	Internal fault
	Accuracy of values	Analog Input	Internal sensor fault

"Home"	Status	"Settings"	"Assist"
	Estimated flow	Function of analog input	Forced pumping
	Volume	Not active	Undervoltage
	Operating log	Differential-pressure control	Overvoltage
	Operating hours	Constant-temperature control	High motor temperature
	Trend data	Differential-temperature control	External sensor fault
	Duty point over time	Heat energy monitor	High liquid temperature
	3D showing (Q, H, t)	External setpoint influence	Comm. fault, twin-head pump
	3D showing (Q, T, t)	Unit	
	3D showing (Q, P, t)	°C	
	3D showing (T, P, t)	°F	
	Fitted modules	Sensor range, min. value	
	Date and time	Sensor range, max. value	
	Date	Electrical signal	
	Time	0-10 V	
	Pump identification	4-20 mA	
	Multipump system	Relay outputs	
	Operating status	Relay output 1	
	Operating mode, from	Not active	
	Control mode	Ready	
	System performance	Alarm	
	Duty point	Operation	
	Resulting setpoint	Relay output 2	
	System identification	Not active	
	Power and energy consumption	Ready	
	Power consumption	Alarm	
	Energy consumpt.	Operation	
	Other pump, multipump system	Operating range	
	Operating mode, from	Set min. speed	
	Speed	Set max. speed	
	Operating hours	Setpoint influence	

"Home"	Status	"Settings"	"Assist"
	Pump identification	External setpoint function	
	Power consumption	Not active	
	Actual warning or alarm	Linear with Min.	
		Linear with Stop <sup>1)</sup>	
		Temperature influence	
		Not active	
		Active, Tmax. = 50 °C	
		Active, Tmax. = 80 °C	
		Bus communication	
		Pump number	
		Forced local mode	
		Enable	
		Disable	
		Multipump profile selection	
		Compatibility for models A, B, C	
		Generic Grundfos profile	
		Automatic	
		General settings	
		Language	
		Set date and time	
		Select date format	
		Set date	
		Select time format	
		Set time	
		Units	
		SI or US units	
		Customised units	
		Differential pressure	
		Head	
		Level	
		Flow rate	
		Volume	
		Temperature	
		Differential temp.	
		Electrical power	

"Home"	Status	"Settings"	"Assist"
		Electrical energy	
		Heat power	
		Heat energy	
		Enable/disable settings	
		Enable	
		Disable	
		Alarm and warning settings	
		Internal sensor fault (88)	
		Enable	
		Disable	
		Internal fault (157)	
		Enable	
		Disable	
		Delete history	
		Delete operating log	
		Delete heat energy data	
		Delete energy consumption	
		Define Home display	
		Select Home display type	
		List of data	
		Graphical illustration	
		Define Home display contents	
		List of data	
		Graphical illustration	
		Display brightness	
		Brightness	
		Return to factory settings	
		Run start-up guide	

<sup>1)</sup> Available for pumps with production code from 1838.

<sup>2)</sup> Activated when the pump experiences a flow below 10 %. See section Low-flow indication.

#### Related information

[9.5.1 Low-flow indication](#)

[9.5.1 Low-flow indication](#)

[9.5.1 Low-flow indication](#)

## 9.5 "Home" menu

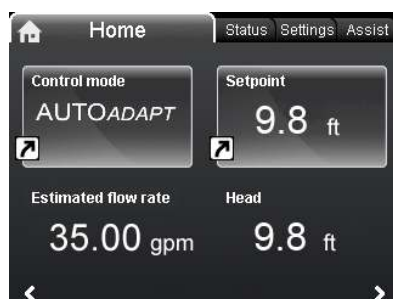

### Navigation

#### "Home"

Press to go to the "Home" menu.

This menu offers the following (factory setting):

- Shortcut to "Control mode" settings
- Shortcut to "Setpoint" settings
- **Estimated flow**
- **Head**.

Navigate in the display with or , and change between the two shortcuts with or .

### Display icons

Symbol	Description
	Automatic night setback function is enabled.
	Settings are locked. You cannot adjust settings from the display.
	The pump is in remote mode, for example from fieldbus.
	The multipump system is active.
	Master pump in a multipump system.
	Slave pump in a multipump system.
	Forced local mode is active. You cannot set the pump to remote mode, for example from fieldbus.
	Radio communication disabled. The radio communication is enabled/disabled by pressing connect button for 15 seconds.

You can define the "Home" display. See section General settings .

### Related information

- *[TOPIC NOT IN MAP (empty topicContent)]*  
[href=task-dO1mt0y.dita](#)
- *[TOPIC NOT IN MAP (empty topicContent)]*  
[href=task-dO1mt0y.dita](#)

#### 9.7.11 "General settings"

## 9.5.1 Low-flow indication

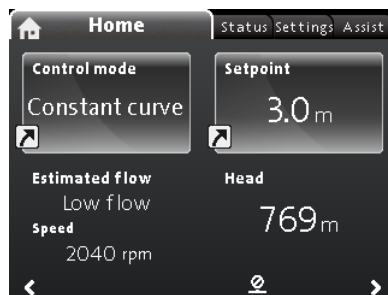

**Note:** Available for pumps with production code from 1838.

The pump can experience low flow due to for example valves being shut. In cases where the flow is below 10 %, thus too low for the pump's internal sensor to measure, it will be stated in the "Home" menu. The speed below the low-flow indication tells you that the pump is still running.

When the flow is high enough for the pump to measure, the "Home" display will return back to normal.

## 9.6 Status menu

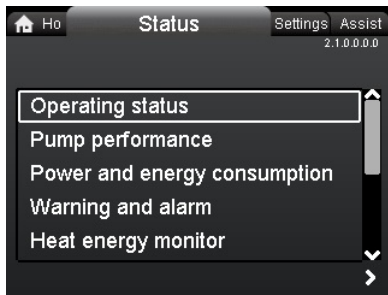

### Navigation

"Home" > Status

Press **Ⓜ** and go to the **Status** menu with **➤**.

This menu offers status information on the following:

- **Operating status**
- **Pump performance**
- **Power and energy consumption**
- **Warning and alarm**
- **Heat energy monitor**
- **Operating log**
- **Fitted modules**
- **Date and time**
- **Pump identification**
- **Multipump system**

Navigate between the submenus with **▼** or **▲**. Choose a submenu with **➤** and return to the **Status** menu with **◀**.

Detailed information on "**Heat energy monitor**" is available in the following section Heat energy monitor.

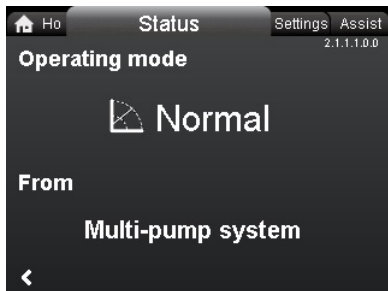

Example of the submenu "**Operating status**" showing the pump running in normal operation in a multipump system.

### Related information

[9.6.1 "Heat energy monitor"](#)

## 9.6.1 "Heat energy monitor"

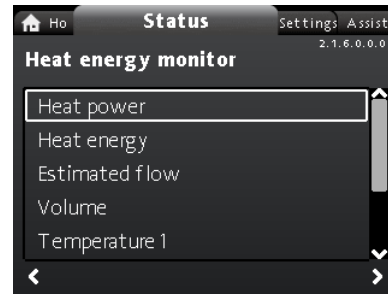

### Navigation

"Home" > Status > "Heat energy monitor"

The "**Heat energy monitor**" calculates the heat energy consumption within a system. For detailed information, see section Heat energy monitor.

Learn how to set an input temperature sensor for monitoring heat energy, in section "Setup, analog input".

The following submenus are explored in the following:

- **Heat energy**
- **Estimated flow**
- **Accuracy of values.**

"Heat energy"

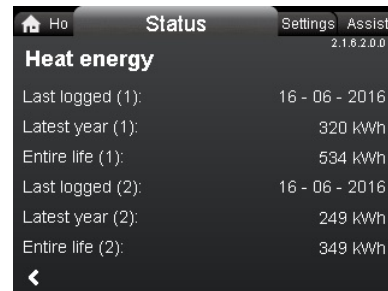

### Navigation

"Home" > Status > "Heat energy monitor" > "Heat energy"

You can measure both heating and cooling in the same system. If a system is used for both heating and cooling, two counters are automatically shown in the display.

The time stamp of the date indicates the latest use of the specific counter.

The value of "**Latest year (2):**" represents the last 52 consecutive weeks where the pump has been supplied with power. The user can reset the value manually. See section "General settings".

"Estimated flow"

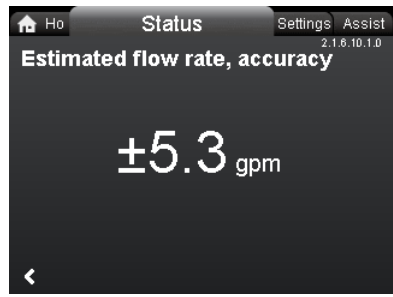

ESTIMATEDFLOWRATE

Navigation

"Home" > "Status" > "Heat energy monitor" > "Estimated flow"

The internal sensor estimates the difference in pressure between the inlet and outlet ports of the pump. The measurement is not a direct differential-pressure measurement, but by knowing the hydraulic design of the pump, you can estimate the differential pressure across the pump.

For further information, see section Flow estimation accuracy.

"Accuracy of values"

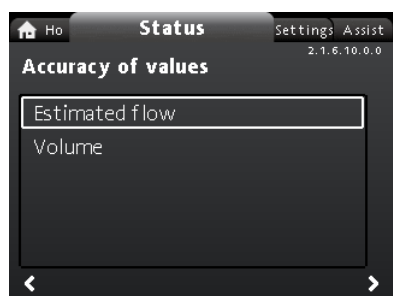

2

Navigation

"Home" > "Status" > "Heat energy monitor" > "Accuracy of values"

This menu offers the following options:

- Estimated flow
- Volume.

Select submenu with  $\downarrow$  or  $\uparrow$ .

This menu allows you to view the current flow rate tolerance and the average volume accuracy over the last 52 consecutive weeks ("Latest year") and the pump's entire life span.

The table in section External connections shows the flow accuracy of the complete MAGNA3 range.

Related information

- [8.6 Flow estimation accuracy](#)
- [8.7 External connections](#)
- [8.9.5 Heat energy monitor](#)
- [9.7.11 "General settings"](#)
- [9.8.4 "Setup, analog input"](#)

9.7 "Settings" menu

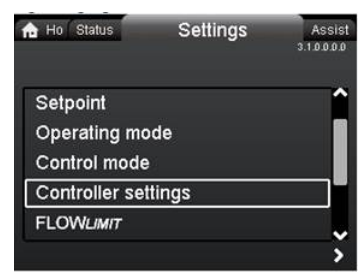

Navigation

"Home" > "Settings"

Press  $\text{Ⓢ}$  and go to the "Settings" menu with  $\rightarrow$ .

This menu offers the following options:

- Setpoint
- Operating mode
- Control mode
- Controller settings, not model A
- FLOWLIMIT
- Automatic Night Setback
- Analog Input
- Relay outputs
- Setpoint influence
- Bus communication
- General settings.

Navigate between the submenus with  $\downarrow$  or  $\uparrow$ .

### 9.7.1 "Setpoint"

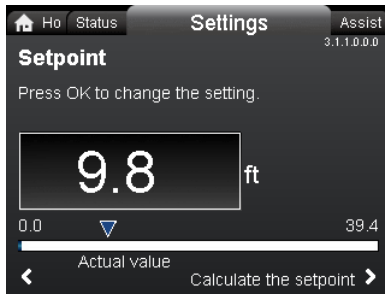

#### Navigation

"Home" > "Settings" > "Setpoint"

#### Setting

1. Press [OK].
2. Select digit with < and > and adjust with v or ^ .
3. Press [OK] to save.

You can set the setpoint with an accuracy of 0.1 metre. The head against a closed valve is the setpoint.

Set the setpoint so that it matches the system. A too high setting may result in noise in the system whereas a too low setting may result in insufficient heating or cooling in the system.

Control mode	Measuring unit
Proportional pressure	m, ft
Constant pressure	m, ft
Constant temperature	°C, °F, K
Constant curve	%

### 9.7.2 "Operating mode"

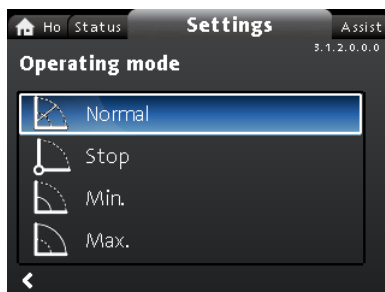

#### Navigation

"Home" > "Settings" > "Operating mode"

This menu offers the following options:

- **Normal**
- **Stop**
- **Min.**
- **Max.**

#### Setting

1. Select operating mode with v or ^ .
2. Press [OK] to save.

For detailed information about the operating modes, see section Operating modes.

#### Related information

- [8.2 Operating modes](#)
- [8.2 Operating modes](#)
- [8.2 Operating modes](#)

### 9.7.3 "Control mode"

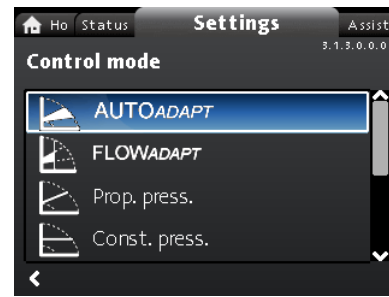

#### Navigation

"Home" > "Settings" > "Control mode"



Set the operating mode to **"Normal"** before you enable a control mode.

#### This menu offers the following options:

- **AUTOADAPT** (the pump starts with the factory setting)
- **FLOWADAPT**
- **Prop. press.** (proportional pressure)
- **Const. press.** (constant pressure)
- **Const. temp.** (constant temperature)
- **Differential temp.** (differential temperature)
- **Constant flow** (available for pumps with production code from 1838)
- **Constant curve**

#### Setting

1. Select control mode with v or ^ .
2. Press [OK] to enable the control mode.

For details on the different control modes, see section Control models.

#### Setpoint

When you have selected the desired control mode, you can change the setpoint for all control modes, except AUTOADAPT and FLOWADAPT, in the **"Setpoint"** submenu. See section "Setpoint".

#### Control mode features

You can combine all control modes, except **"Constant curve"**, with automatic night setback. See section "FLOWLIMIT".

You can also combine the FLOWLIMIT function with the control modes mentioned above. See section "FLOWLIMIT".

#### Related information

- [8.3.1 Factory setting](#)
- [9.7.5 "FLOW LIMIT"](#)
- [9.7.1 "Setpoint"](#)

### 9.7.4 "Controller settings" (not model A)

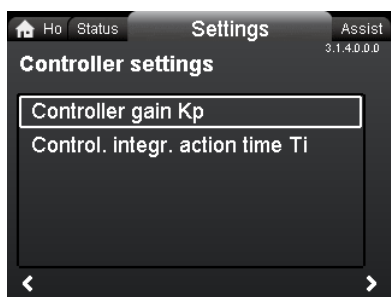

#### Navigation

"Home" > "Settings" > "Controller settings"

This menu offers the following options:

- **Controller gain Kp**
- **Control. integr. action time Ti.**
- **Temperature sensor offset** (available for pumps with production code from 1838).

#### Setting

1. Select "Controller settings" with  $\downarrow$  or  $\uparrow$  and press [OK].
2. Choose either "Controller gain Kp" or "Control. integr. action time Ti" with  $\downarrow$  or  $\uparrow$ . Press [OK].
3. Press [OK] to start the setting.
4. Select digit with  $\leftarrow$  and  $\rightarrow$  and adjust with  $\downarrow$  or  $\uparrow$ .
5. Press [OK] to save.

A change of the gain and integral-time values affects all control modes. If you change the control mode to another control mode, change the gain and integral-time values to the factory settings.

The gain,  $K_p$ , is equal to 1.

The integral time,  $T_i$ , is equal to 8.

The table below shows the suggested controller settings:

If you use a built-in temperature sensor as one of the sensors, you must install the pump as close as possible to the consumer.

System/application	$K_p$		$T_i$
	Heating system <sup>1)</sup>	Cooling system <sup>2)</sup>	
 TM011784	0.5	- 0.5	10 + 5 ( $L_1 + L_2$ )
 TM011786	0.5	- 0.5	30 + 5 $L_2$

<sup>1)</sup> In heating systems, an increase in pump performance results in a rise in temperature at the sensor.

<sup>2)</sup> In cooling systems, an increase in pump performance results in a drop in temperature at the sensor.

L1: Distance in meters between pump and consumer.

L2: Distance in meters between consumer and sensor.

### Guidelines for setting of PI controller

For most applications, the factory setting of the controller constants, gain and integral time, ensures optimum pump operation. However, in some applications an adjustment of the controller may be required.

You find the setpoint displayed in figures below. For further information about setup, see the "Assist" menu in section "Application wizard".

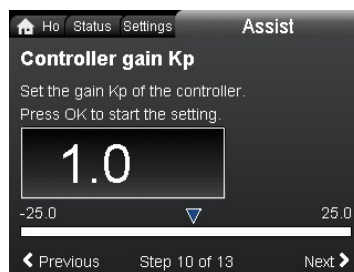

"Controller gain Kp"

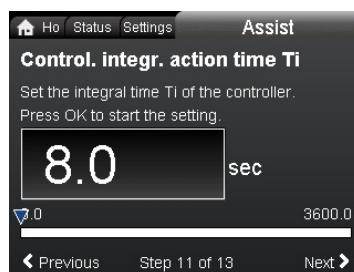

"Control. integr. action time Ti"

Proceed as follows:

1. Increase the gain until the motor becomes unstable. Instability can be seen by observing if the measured value starts to fluctuate. Furthermore, instability is audible as the motor starts hunting up and down.  
Some systems, such as temperature controls, are slow-reacting, meaning that it may be several minutes before the motor becomes unstable.
2. Set the gain to half the value of the value which made the motor unstable.
3. Reduce the integral time until the motor becomes unstable.
4. Set the integral time to twice the value which made the motor unstable.

#### Rules of thumb

If the controller is too slow-reacting, increase the gain.

If the controller is hunting or unstable, dampen the system by reducing the gain or increasing the integral time.

Change the control settings by means of the display or Grundfos GO. You can set both positive and negative values.

#### Related information

[9.8.1 "Application wizard"](#)

TM079202

TM079203

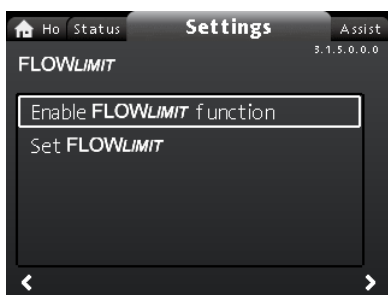
9.7.5 "FLOW *LIMIT*"**Navigation**

"Home" > "Settings" > "FLOW *LIMIT*"

This menu offers the following options:

- Enable FLOW *LIMIT* function
- Set FLOW *LIMIT*.

**Setting**

1. To enable the function, select "Enable FLOW *LIMIT* function" with  $\downarrow$  or  $\uparrow$  and press [OK].
2. To set the FLOW *LIMIT*, press [OK].
3. Select digit with  $\leftarrow$  and  $\rightarrow$  and adjust with  $\downarrow$  or  $\uparrow$ .
4. Press [OK] to save.

You can combine the FLOW *LIMIT* function with the following control modes:

- FLOWADAPT
- Prop. press.
- Const. press.
- Const. temp.
- Constant curve
- Differential temp..

For more information about FLOW *LIMIT*, see section FLOW *LIMIT*.

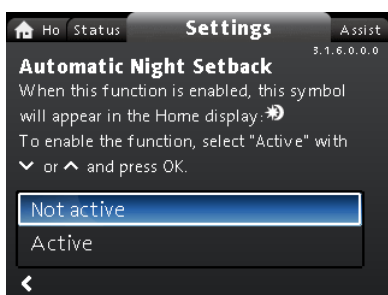
**"Automatic Night Setback"****Navigation**

"Home" > "Settings" > "Automatic Night Setback"

**Setting**

To enable the function, select "Active" with  $\downarrow$  or  $\uparrow$  and press [OK].

For more information about **Automatic Night Setback**, see section Automatic night setback.

**Related information**

[8.4.1 FLOWLIMIT](#)

[8.4.2 Automatic night setback](#)

## 9.7.6 "Analog Input"

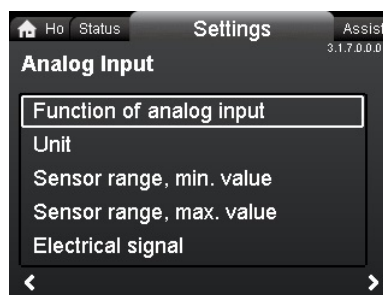
**Navigation**

"Home" > "Settings" > "Analog Input"

This menu offers the following options:

- Function of analog input
- Unit
- Sensor range, min. value
- Sensor range, max. value
- Electrical signal.

**Setting**

1. Choose "Function of analog input" with  $\downarrow$  or  $\uparrow$  and press [OK].
2. Choose the function of input with  $\downarrow$  or  $\uparrow$ :
  - Not active**
  - Differential-pressure control**
  - Constant-temperature control**
  - Differential-temperature control
  - Heat energy monitor**
  - External setpoint influence
3. Press [OK] to enable the function mode.
 

When you have selected the desired function, specify the sensor parameters:
4. Return to the "Analog Input" menu with  $\leftarrow$ .
5. Now adjust the sensor parameters "Unit", "Sensor range, min. value", "Sensor range, max. value" and "Electrical signal".
6. Choose the desired parameter with  $\downarrow$  or  $\uparrow$  and press [OK].
7. Select value or adjust digits with  $\downarrow$  or  $\uparrow$  and press [OK].
8. Return to the "Analog Input" menu with  $\leftarrow$ .

**Note:** You can also use the "Assist" menu to set the analog input. Here a wizard guides you through each step of the configuration. See section "Setup, analog input".

For more information on "Analog Input", see section Analog input. For further information on "Heat energy monitor" see section Heat energy monitor.

**Related information**

[8.9.4 Analog input](#)

[8.9.5 Heat energy monitor](#)

[9.8.4 "Setup, analog input"](#)

### 9.7.7 "Relay outputs"



#### Navigation

"Home" > "Settings" > "Relay outputs"

This menu offers the following options:

- Relay output 1
- Relay output 2.

#### Setting

1. Choose "**Relay output 1**" with  $\downarrow$  or  $\uparrow$  and press [OK].
2. Choose the function of input with  $\downarrow$  or  $\uparrow$  :
  - "**Not active**": The signal relay is deactivated.
  - "**Ready**": The signal relay is active when the pump is running or has been set to stop, but is ready to run.
  - "**Alarm**": The signal relay is activated together with the red indicator light on the pump.
  - "**Operation**": The signal relay is activated together with the green indicator light on the pump.
3. Press [OK] to save.

Repeat steps 1-3 for "**Relay output 2**".

For detailed information on "**Relay outputs**", see section Relay outputs.

The duty ranges for proportional-pressure and constant-pressure control appear from the data sheets in the *MAGNA3 data booklet*. In constant-curve duty, you can control the pump from minimum to 100 %. The range of control depends on the minimum speed, power and pressure limits of the pump.

#### Related information

- [TOPIC NOT IN MAP (empty topicContent)]  
*href=reference-WtvxQoP.dita*
- [TOPIC NOT IN MAP (empty topicContent)]  
*href=reference-WtvxQoP.dita*

[8.9.2 Relay outputs](#)

### 9.7.8 Operating range

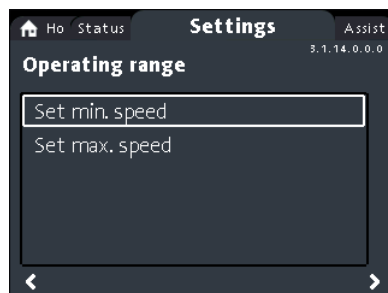

#### Navigation

"Home" > "Settings" > "Operating range"

This menu offers the following options:

- Set min. speed
- Set max. speed.

#### Setting

The minimum and maximum curve can be adjusted. Do as follows:

1. Choose "**Set min. speed**" with  $\downarrow$  or  $\uparrow$  and press [OK].
2. Press [OK].
3. Select digit with  $\leftarrow$  and  $\rightarrow$  and adjust with  $\downarrow$  or  $\uparrow$  .
4. Press [OK] to save.

Repeat steps 1 to 4 for "**Set max. speed**".

### 9.7.9 "Setpoint influence"

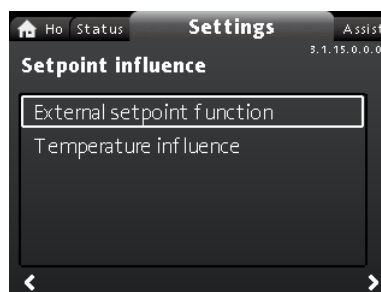

#### Navigation

"Home" > "Settings" > "Setpoint influence"

This menu offers the following options:

- External setpoint function
- Temperature influence.

"External setpoint function"

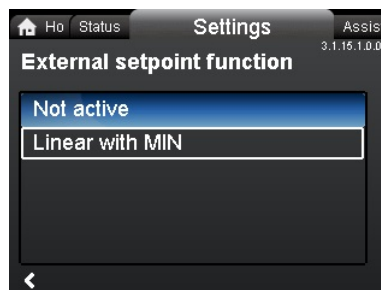

#### Navigation

"Home" > "Settings" > "Setpoint influence" > "External setpoint function"

#### Setting

1. Select "**Linear with Min.**" or "**Linear with Stop**" (available for pumps with production code from 1838) with  $\downarrow$  or  $\uparrow$  and press [OK].

Note: The analog input must be set to "External setpoint influence" before the "External setpoint function" can be enabled.

If the analog input is set to external setpoint influence, the external setpoint function is automatically activated with "Linear with Min.". See section Analog input.

For detailed information on "External setpoint function", see section External setpoint function.

### "Temperature influence"

#### Navigation

"Home" > "Settings" > "Setpoint influence" > "Temperature influence"

This menu offers the following options:

- Not active
- Active,  $T_{max.} = 120\text{ }^{\circ}\text{F}$
- Active,  $T_{max.} = 170\text{ }^{\circ}\text{F}$ .

#### Setting

1. Select "Temperature influence" with  $\downarrow$  or  $\uparrow$  and press [OK].
2. Choose the desired maximum temperature with  $\downarrow$  or  $\uparrow$  and press [OK].

When this function is enabled in proportional- or constant-pressure control mode, the setpoint for head is reduced according to the liquid temperature.

You can set the temperature influence to function at liquid temperatures below 176 or 122 °F (80 or 50 °C). These temperature limits are called  $T_{max.}$ . The setpoint is reduced in relation to the head set which is equal to 100 %, according to the characteristics below.

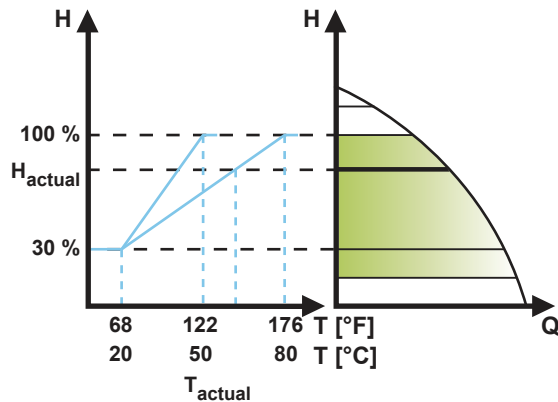

TM057946

### "Temperature influence"

In the above example,  $T_{max.}$ , which is equal to 176 °F (80 °C), has been selected. The actual liquid temperature,  $T_{actual}$ , causes the setpoint for head to be reduced from 100 % to  $H_{actual}$ .

#### Requirements

The temperature influence function requires the following:

- proportional-pressure, constant-pressure or constant-curve control mode
- pump installed in flow pipe
- system with flow-pipe temperature control.

Temperature influence is suitable for the following systems:

- Systems with variable flows for example two-pipe heating systems, in which the enabling of the temperature influence function ensures a further reduction of the pump performance in periods with small heating demands and consequently a reduced flow-pipe temperature.
- Systems with almost constant flows, for example one-pipe heating systems and underfloor heating systems, in which variable heating demands cannot be registered as changes in

the head as is the case with two-pipe heating systems. In such systems, you can only adjust the pump performance by enabling the temperature influence function.

### Selection of maximum temperature

In systems with a dimensioned flow-pipe temperature:

- Up to and including 131 °F (55 °C), select a maximum temperature equal to 122 °F (50 °C).
- Above 131 °F (55 °C), select a maximum temperature equal to 176 °F (80 °C).

You cannot use the temperature influence function in air-conditioning and cooling systems.

### Related information

[8.9.4 Analog input](#)

[8.9.6 External setpoint function](#)

### 9.7.10 "Bus communication"

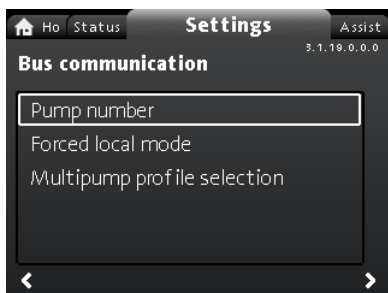

#### Navigation

"Home" > "Settings" > "Bus communication"

This menu offers the following options:

- Pump number
- Forced local mode

"Pump number"

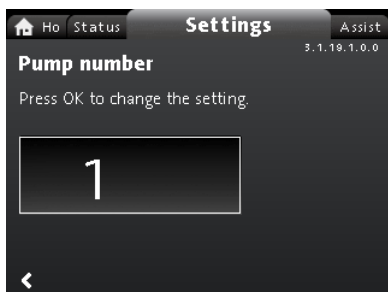

#### Navigation

"Home" > "Settings" > "Bus communication" > "Pump number"

#### Setting

1. Press [OK] to start the setting. The pump allocates a unique number to the pump.

The unique number enables you to distinguish between the pumps in connection with bus communication.

"Forced local mode"

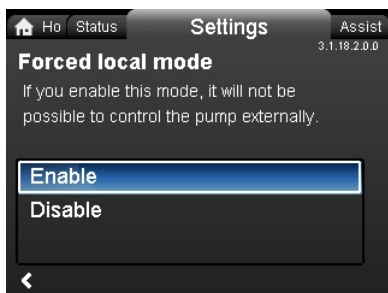

#### Navigation

"Home" > "Settings" > "Bus communication" > "Forced local mode"

#### Setting

To enable the function, choose "Enable" with  $\downarrow$  or  $\uparrow$  and press [OK]. To disable the function, choose "Disable" with  $\downarrow$  or  $\uparrow$  and press [OK].

You can temporarily override remote commands from a building management systems to make local settings. Once you have disabled "Forced local mode", the pump reconnects to the network when it receives a remote command from the building management system.

### "Multipump profile selection"

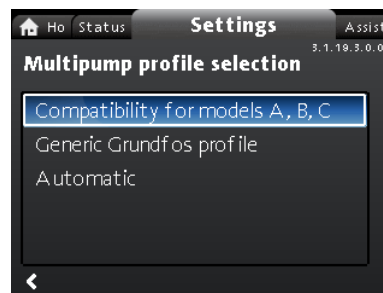

#### Navigation

"Home" > "Settings" > "Bus communication" > "Multipump profile selection"

This menu offers the following options:

- Compatibility for models A, B, C
- Generic Grundfos profile
- Automatic.

#### Setting

Select mode with  $\downarrow$  and  $\uparrow$  and press [OK].



Multipump profile mode must be chosen from the pump assigned as master.

The MAGNA3 from model D pump is able to automatically detect and adjust itself to an existing system with older version pumps or an older BMS. You enable this function by choosing "Automatic" in the display.

"Generic Grundfos profile" overrules auto detection, and the pump runs as a MAGNA 3 from Model D and onwards. However, if your BMS system or existing pumps are older versions, we recommend that you choose either "Automatic" or "Compatibility for models A, B, C".

See section [Auto detection of CIM modules](#) for further information on auto detection.

#### Related information

[12.2.4 Auto detection of CIM modules](#)

### 9.7.11 "General settings"

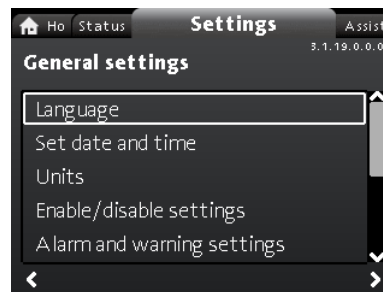

#### Navigation

"Home" > "Settings" > "General settings"

This menu offers the following options:

- Language
- Set date and time
- Units
- Enable/disable settings
- Alarm and warning settings
- Delete history
- Define Home display
- Display brightness
- Return to factory settings

- Run start-up guide.

## "Language"

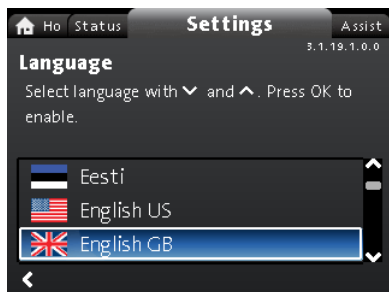

### Navigation

"Home" > "Settings" > "General settings" > "Language"

### Setting

1. Select language with  $\downarrow$  and  $\uparrow$ .
2. Press [OK] to enable the language.

The display can be shown in any of the following languages:

- Bulgarian
- Croatian
- Czech
- Danish
- Dutch
- English (US or British)
- Estonian
- Finnish
- French
- German
- Greek
- Hungarian
- Italian
- Japanese
- Korean
- Latvian
- Lithuanian
- Polish
- Portuguese
- Romanian
- Russian
- Serbian
- Simplified Chinese
- Slovak
- Slovenian
- Spanish
- Swedish
- Turkish
- Ukrainian.

Measuring units are automatically changed according to the selected language.

## "Set date and time"

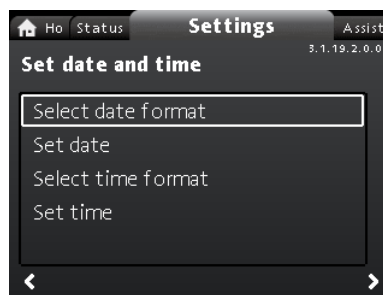

### Navigation

"Home" > "Settings" > "General settings" > "Set date and time"

This menu offers the following options:

- **Select date format**
- **Set date**
- **Select time format**
- **Set time.**

### Setting the date

1. Choose "**Select date format**" with  $\downarrow$  or  $\uparrow$  and press [OK]. Choose either "YYYY-MM-DD", "DD-MM-YYYY" or "MM-DD-YYYY".
2. Press  $\leftarrow$  to return to "**Set date and time**".
3. Select "**Set date**" with  $\downarrow$  or  $\uparrow$  and press [OK].
4. Select digit with  $\leftarrow$  and  $\rightarrow$  and adjust with  $\downarrow$  or  $\uparrow$ .
5. Press [OK] to save.

### Setting the time

1. Choose "**Select time format**" with  $\downarrow$  or  $\uparrow$  and press [OK]. Choose either "HH:MM 24-hour clock" or "HH:MM am/pm 12-hour clock".
2. Press  $\leftarrow$  to return to "**Set date and time**".
3. Select "**Set time**" with  $\downarrow$  or  $\uparrow$  and press [OK].
4. Select digit with  $\leftarrow$  and  $\rightarrow$  and adjust with  $\downarrow$  or  $\uparrow$ .
5. Press [OK] to save.

## "Units"

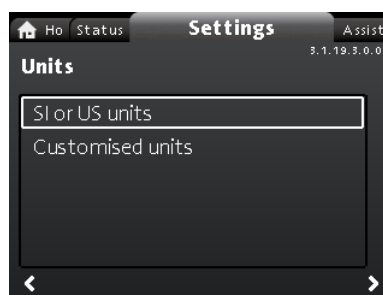

### Navigation

"Home" > "Settings" > "General settings" > "Units"

This menu offers the following options:

- **SI or US units**
- **Customised units.**

In this menu, you can select between SI and US units. The setting can be made generally for all parameters or customized for each individual parameter:

- **Pressure**
- **Differential pressure**
- **Head**
- **Level**
- **Flow rate**
- **Volume**
- **Temperature**

- Differential temp.
- Power
- Energy.

#### Setting, general

1. Select "**SI or US units**" with  $\downarrow$  or  $\uparrow$  and press [OK].
2. Choose either SI or US units with  $\downarrow$  or  $\uparrow$  and press [OK].

#### Setting, customized

1. Select "**Customised units**" with  $\downarrow$  or  $\uparrow$  and press [OK].
  2. Select parameter and press [OK].
  3. Select unit with  $\downarrow$  or  $\uparrow$ . Press [OK].
  4. Return to parameters with  $\leftarrow$ . Repeat steps 2-4 if necessary.
- If you have selected **SI or US units**, the customized units are reset.

#### "Enable/disable settings"

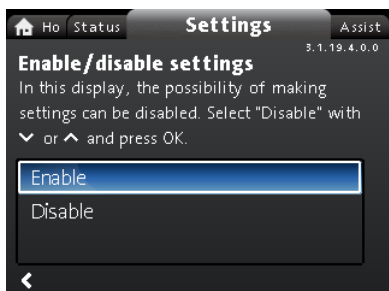

#### Navigation

"Home" > "Settings" > "General settings" > "Enable/disable settings"

#### Setting

5. Select "**Disable**" with  $\downarrow$  or  $\uparrow$  and press [OK]. The pump is now locked for settings. Only the "**Home**" display is available.

In this display, you can disable the possibility of making settings. To unlock the pump and allow settings, press  $\downarrow$  and  $\uparrow$  simultaneously for at least 5 seconds or enable the settings again in the menu.

#### "Alarm and warning settings"



#### Navigation

"Home" > "Settings" > "General settings" > "Alarm and warning settings"

This menu offers the following options:

- Internal sensor fault (88)
- Internal fault (157).

#### "Internal sensor fault (88)"

#### Navigation

"Home" > "Settings" > "General settings" > "Internal sensor fault (88)"

#### Setting

1. Select either "**Enable**" or "**Disable**" with  $\downarrow$  or  $\uparrow$  and press [OK].

In case of a sensor problem related to the quality of the liquid, the pump is able to continue operation with satisfactory performance in most situations. In such situations, you can disable "**Internal sensor fault (88)**".

#### "Internal fault (157)"

#### Navigation

"Home" > "Settings" > "General settings" > "Internal fault (157)"

#### Setting

1. Select either "**Enable**" or "**Disable**" with  $\downarrow$  or  $\uparrow$  and press [OK].

If the real-time clock is out of order, for example due to a dead battery, a warning is shown. You can disable the warning.

#### "Delete history"

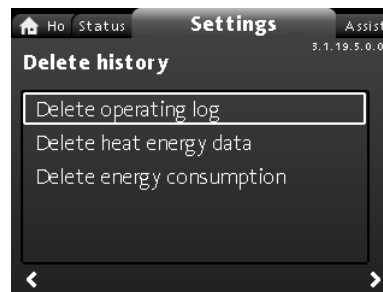

#### Navigation

"Home" > "Settings" > "General settings" > "Delete history"

This menu offers the following options:

- Delete operating log
- Delete heat energy data
- Delete energy consumption.

#### Setting

1. Select submenu with  $\leftarrow$  or  $\rightarrow$  and press [OK].
2. Select "**Yes**" with  $\downarrow$  or  $\uparrow$  and press [OK] or press  $\odot$  to cancel.

You can delete data from the pump, for example if the pump is moved to another system or if new data are required due to changes to the system.

#### "Define Home display"

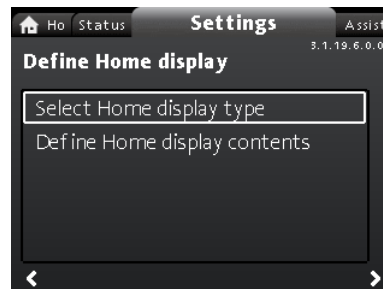

#### Navigation

"Home" > "Settings" > "General settings" > "Define Home display"

This menu offers the following options:

- Select Home display type
  - List of data
  - Graphical illustration
- Define Home display contents.
  - List of data.

In this menu, you can set the "**Home**" display to show up to four user-set parameters or a graphical illustration of a performance curve.

1. Choose "**Select Home display type**" with  $\downarrow$  or  $\uparrow$  and press [OK].
2. Select "**List of data**" with  $\downarrow$  or  $\uparrow$ . Press [OK].
3. A list of parameters appears in the display. Select or deselect with [OK].
4. Return to "**Select Home display type**" with  $\leftarrow$ .
5. Select "**Graphical illustration**" with  $\downarrow$  or  $\uparrow$  and press [OK].

6. Select the desired curve. Press [OK] to save.

To specify the contents, go to **"Define Home display contents"**.

#### Setting: "Define Home display contents"

1. Choose **"Define Home display contents"** with  $\downarrow$  or  $\uparrow$  and press [OK].
2. To set **"List of data"** with  $\downarrow$  or  $\uparrow$ . Press [OK].
3. A list of parameters appears in the display. Select or deselect with [OK].

The selected parameters are now visible in the **"Home"** menu. See figure below. The arrow indicates that the parameter links to the **"Settings"** menu and works as a shortcut for quick settings.

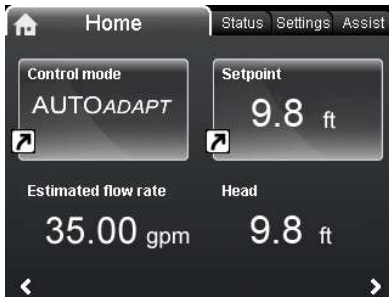

Example: **"Home"** menu parameters

#### "Display brightness"

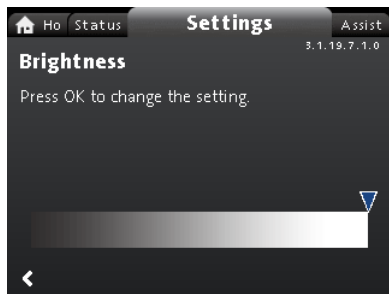

#### Navigation

**"Home"** > **"Settings"** > **"General settings"** > **"Display brightness"**

#### Setting

1. Press [OK].
2. Set brightness with  $\leftarrow$  and  $\rightarrow$ .
3. Press [OK] to save.

#### "Return to factory settings"

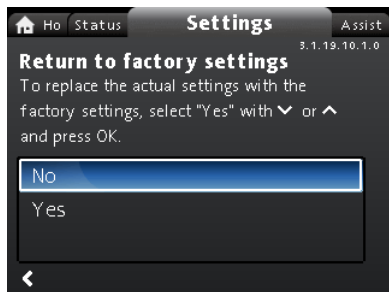

#### Navigation

**"Home"** > **"Settings"** > **"General settings"** > **"Return to factory settings"**

#### Setting

To overwrite the current settings with the factory settings, select **"Yes"** with  $\downarrow$  or  $\uparrow$  and press [OK].

You can recall the factory settings and overwrite the current settings. All user settings in the **"Settings"** and **"Assist"** menus are set back to the factory settings. This also includes language, units, setup of analog input, multipump function, etc.

#### "Run start-up guide"

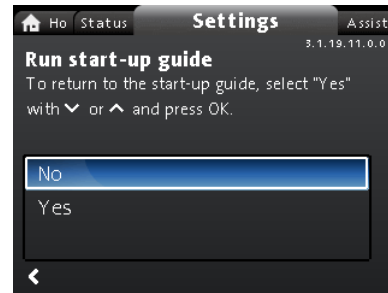

#### Navigation

**"Home"** > **"Settings"** > **"General settings"** > **"Run start-up guide"**

#### Setting

To run the startup guide, select **"Yes"** with  $\downarrow$  or  $\uparrow$  and press [OK].

The startup guide automatically starts when you start the pump for the first time; however, you can always run the startup guide later via this menu.

The startup guide guides the user through the general settings of the pump, such as language, date and time.

UNDEF-010\_HOME\_US

3

3

## 9.8 "Assist" menu

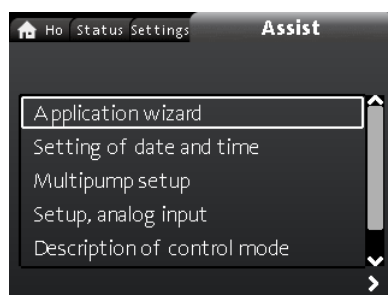

### Navigation

"Home" > "Assist"

Press **Ⓢ** and go to the "Assist" menu with **▶**.

The menu guides you through and offers the following:

- **Application wizard** (available for pumps with production code from 1838)
- **Setting of date and time**
- **Multipump setup**
- **Setup, analog input**
- **Description of control mode**
- **Assisted fault advice.**

The "Assist" menu guides the user through the setting of the pump. In each submenu, there is a guide that guides the user through the setting of the pump.

### 9.8.1 "Application wizard"

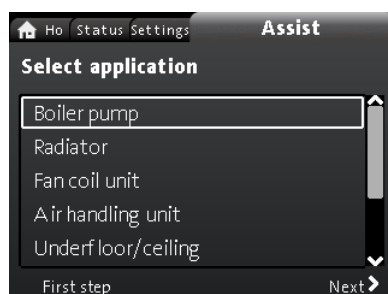

Available for pumps with production code from 1838.

### Navigation

"Home" > "Assist" > "Application wizard"

This menu guides you through a complete pump setup and helps you set the correct control mode.

Applications available in this menu:

- **Boiler pump**
- **Radiator**
- **Fan coil unit**
- **Air handling unit**
- **Underfloor/ceiling**
- **Hot water**
- **Ground source**
- **Chiller pump.**

### Setting

1. Choose the system that applies to the function of your pump with **▼** or **▲** and press [OK] followed by **▶**.
2. Select the characteristics applicable to your system with **▼** or **▲** and press [OK] followed by **▶**.
3. Continue this process until the setup has been completed.

If you wish to change the selected control mode, either launch the "Application wizard" again or choose a control mode in the "Settings" menu. See section "Control mode".

The application wizard menu which guides through a complete pump setup and set correct control mode in available in Grundfos go app. This helps to perform above settings remotely using smart phones.

### Related information

- [TOPIC NOT IN MAP (empty topicContent)]  
*href=task-oP4kct8.dita*
- [TOPIC NOT IN MAP (empty topicContent)]  
*href=task-oP4kct8.dita*

[9.7.3 "Control mode"](#)

### 9.8.2 "Setting of date and time"

#### Navigation

"Home" > "Assist" > "Setting of date and time"

This menu guides you through the setup of time and date. See also section "General settings".

### Related information

[9.7.11 "General settings"](#)

### 9.8.3 "Multipump setup"

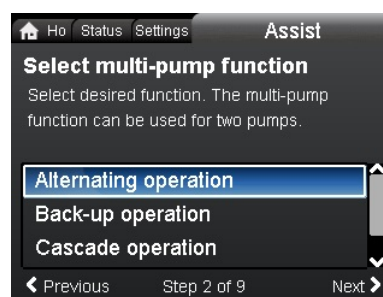

### Navigation

"Home" > "Assist" > "Multipump setup"

This menu offers the following options:

- **Alternating operation**
- **Back-up operation**
- **Cascade operation**
- **No multipump function.**

Setting: "Alternating operation", "Back-up operation" and "Cascade operation"

1. Select the desired operating mode with **▼** or **▲** and press [OK].
2. Follow the step-by-step guide to complete the multipump setup.
3. Check the entered values.
4. Press [OK] to confirm and enable the settings.

You can set a multipump system from a selected pump, which will then be the master pump. Check the display to identify the master pump in a multipump system. See figure below and section "Home" menu.

UNDEF-083\_ASSIST\_MULTIPUMP\_SELECTMULTIPUMP

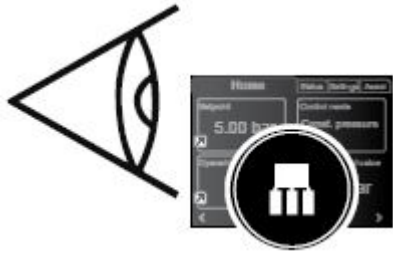

TM067499

Identify the master pump in a multipump system

A twin-head pump is set to multipump function from factory. Here pump head I is defined as master pump. Check the nameplate to identify the master pump. See figure below.

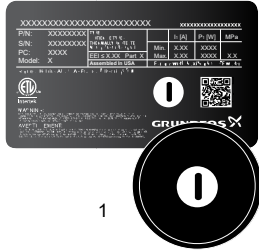

TM069088

Identify the master pump on a twin-head pump

Pos.	Description
1	I is defined as master

For detailed information on the control modes, see section Multipump function.

**Setting: "No multipump function"**

1. Select the "No multipump function " with  $\downarrow$  or  $\uparrow$  and press [OK].
2. The pumps run as single-head pumps.

**Related information**

- [8.5.1 Multipump function](#)
- [9.5 "Home" menu](#)

**9.8.4 "Setup, analog input"**

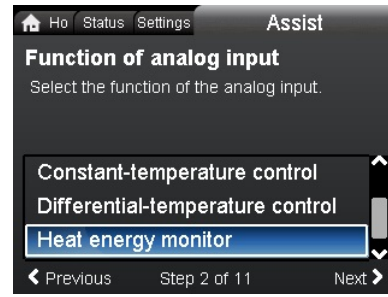

FUNCTION\_OF\_ANALOG\_INPUT

**Navigation**

"Home" > "Assist" > "Setup, analog input"

**Setting, example: Analog input > "Heat energy monitor"**

1. To enable the sensor input, select "Heat energy monitor" with  $\downarrow$  or  $\uparrow$  and press [OK].
2. Follow the step-by-step guide to complete the sensor-input setup. Start with the unit display, see figure below, and end with the summary display.

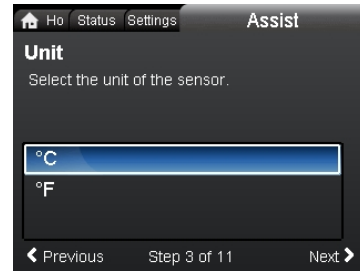

TM079204

Step-by-step guide, "Heat energy monitor": Unit display

3. Check the entered values.
4. Press [OK] to confirm and enable the settings.

Learn more about "Heat energy monitor" in section Heat energy monitor and "Heat energy" in section "Heat energy monitor".

**Related information**

- [8.9.5 Heat energy monitor](#)
- [9.6.1 "Heat energy monitor"](#)

**9.9 "Description of control mode"**

**Navigation**

"Home" > "Assist" > "Description of control mode"

This menu describes the possible control modes.

**9.10 "Assisted fault advice"**

**Navigation**

"Home" > "Assist" > "Assisted fault advice"

This menu gives guidance and corrective actions in case of pump failures.

## 10. Servicing the product

### Before dismantling

#### WARNING

##### Electric shock



Death or serious personal injury

- Make sure that other pumps or sources do not force flow through the pump even if the pump is stopped. This will cause the motor to act like a generator, resulting in voltage on the pump.

#### WARNING

##### Electric shock



Death or serious personal injury

- Switch off the power supply for at least 3 minutes before you start any work on the product.
- Lock the main disconnect switch to the Off position. Type and requirements as specified in national, state, and local regulations.

#### WARNING

##### Magnetic field



Death or serious personal injury

- Persons with pacemakers disassembling this product must exercise care when handling the magnetic materials embedded in the rotor.

### 10.1 Differential-pressure and temperature sensor

The pump incorporates a differential-pressure and temperature sensor. The sensor is located in the pump housing in a channel between the inlet and outlet ports. The sensors of twin-head pumps are connected to the same channel and the pumps therefore register the same differential pressure and temperature.

Via a cable, the sensor sends an electrical signal for the differential pressure across the pump and for the liquid temperature to the controller in the control box.

If the sensor fails, the pump continues using the last measurement from the sensor and operate based on this. In earlier software versions, model A, the pump runs at maximum speed in case of a sensor fault.

When the fault has been corrected, the pump continues operating according to the parameters set.

The differential-pressure and temperature sensor offers substantial benefits:

- direct feedback on the pump display
- complete pump control
- measurement of the pump load for precise and optimum control resulting in higher energy efficiency.







### 10.2 External sensor condition

In case of missing sensor signal:

- Pumps produced before week 4, 2016: The pump runs at maximum speed.
- Pumps produced after week 4, 2016: The pump runs at 50 % of the nominal speed.



## 11. Fault finding the product

### 11.1 Grundfos Eye operating indications

Grundfos Eye	Indication	Cause
	No lights are on.	The power is off. The pump is not running.
	Two opposite green indicator lights running in the direction of rotation of the pump.	The power is on. The pump is running.
	Two opposite green indicator lights are permanently on.	The power is on. The pump is not running.
	One yellow indicator light running in the direction of rotation of the pump.	Warning. The pump is running.
	One yellow indicator light is permanently on.	Warning. The pump has stopped.
	Two opposite red indicator lights flashing simultaneously.	Alarm. The pump has stopped.
	One green indicator light in the middle is permanently on in addition to another indication.	Remote-controlled. The pump is currently being accessed by Grundfos GO.

#### Signals from Grundfos Eye

The operating condition of the pump is indicated by Grundfos Eye on the operating panel when it communicates with a remote control.

Indication	Description	Grundfos Eye
The green indicator light in the middle flashes quickly four times.	This is a feedback signal which the pump gives in order to ensure identification of itself.	
The green indicator light in the middle flashes continuously.	Grundfos GO or another pump is trying to communicate with the pump. Press [OK] on the pump operating panel to allow communication.	
The green indicator light in the middle is permanently on.	Remote control with Grundfos GO via radio. The pump is communicating with Grundfos GO via radio connection.	

#### 11.1.1 Operating indications related to a multipump system

When connecting Grundfos GO to a multipump setup and choosing 'system view', Grundfos GO indicates the system's operating status and not the status of the pump itself. Therefore, the indicator light in Grundfos GO might differ from the indicator light shown on the pump's operating panel. See table below.

Grundfos Eye, master pump	Grundfos Eye, slave pump	Grundfos Eye, Grundfos GO
Green	Green	Green
Green/yellow	Yellow/red	Yellow
Yellow/red	Green/yellow	Yellow
Red	Red	Red

## 11.2 Fault finding

Reset a fault indication in one of the following ways:

- When you have eliminated the fault cause, the pump reverts to normal duty.
- If the fault disappears by itself, the fault indication is automatically reset.

The fault cause is stored in the pump alarm log.

### CAUTION

#### Pressurized system

Minor or moderate personal injury



- Before dismantling the pump, drain the system or close the isolating valve on either side of the pump. The pumped liquid may be scalding hot and under high pressure.

### WARNING

#### Electric shock

Death or serious personal injury



- Switch off the power supply for at least 3 minutes before you start any work on the product.
- Lock the main disconnect switch to the Off position. Type and requirements as specified in national, state, and local regulations.

### WARNING

#### Electric shock

General warning



- Make sure that other pumps or sources do not force flow through the pump even if the pump is stopped.



If the power supply cable is damaged, it must be replaced by the manufacturer, the manufacturer's service partner or a similarly qualified person.

## 11.3 Fault finding table

Warning and alarm codes	Fault	Automatic reset and restart	Corrective actions
"Pump communication fault" (10) "Alarm"	Communication fault between different parts of the electronics.	Yes	Contact Grundfos Service, or replace the pump. Check if the pump is running in turbine operation. See code (29) " <b>Forced pumping</b> ".
"Forced pumping" (29) "Alarm"	Other pumps or sources force flow through the pump even if the pump is stopped and switched off.	Yes	Switch off the pump on the main disconnect switch. If the light in Grundfos Eye is on, the pump is running in forced-pumping mode. Check the system for defective check valves and replace the valves, if necessary. Check the system for correct position of check valves, etc.
"Undervoltage" (40, 75) "Alarm"	The supply voltage to the pump is too low.	Yes	Make sure that the power supply is within the specified range.
"Blocked pump" (51) "Alarm"	The pump is blocked.	Yes	Dismantle the pump, and remove any foreign matter or impurities preventing the pump from rotating.
"High motor temperature" (64) "Alarm"	The temperature in the stator windings is too high.	No	Contact Grundfos Service, or replace the pump.
"Internal fault" (72 and 155) "Alarm"	Internal fault in the pump electronics. Irregularities in the voltage supply can cause alarm 72.	Yes	There might be turbine flow in the application that forces a flow through the pump. Check if the sensor is blocked by sediments. This can occur if the media is impure. Replace the pump, or contact Grundfos Service.
"Overvoltage" (74) "Alarm"	The supply voltage to the pump is too high.	Yes	Make sure that the power supply is within the specified range.
"Comm. fault, twin-head pump" (77) "Warning"	The communication between pump heads was disturbed or broken.	-	Make sure that the second pump head is powered on or connected to the power supply.
"Internal fault" (84, 85 and 157) "Warning"	Fault in the pump electronics.	-	Contact Grundfos Service, or replace the pump.
"Internal sensor fault" (88) "Warning"	The pump is receiving a signal from the internal sensor which is outside the normal range.	-	Make sure that the plug and cable are connected correctly in the sensor. The sensor is located on the back of the pump housing. Replace the sensor, or contact Grundfos Service.
"External sensor fault" (93) "Warning"	The pump is receiving a signal from the external sensor which is outside the normal range.	-	Does the electrical signal set (0-10 V or 4-20 mA) match the sensor output signal? If not, change the setting of the analog input, or replace the sensor with one that matches the setup. Check the sensor cable for damage. Check the cable connection at the pump and at the sensor. Correct the connection, if required. The sensor has been removed, but the analog input has not been disabled. Replace the sensor, or contact Grundfos Service.



Warnings do not activate the alarm relay.

## 12. Accessories

### 12.1 Grundfos GO

The pump is designed for wireless radio or infrared communication with Grundfos GO. Grundfos GO enables setting of functions and gives access to status overviews, technical product information and actual operating parameters.



The radio communication between the pump and Grundfos GO is encrypted to protect against misuse.

Grundfos GO is available in Apple App Store and Google Play. Grundfos GO replaces the Grundfos R100 remote control. This means that all products supported by R100 are now supported by Grundfos GO.

Grundfos Go app in devices can directly communicate with Pump using bluetooth connection.

You can use Grundfos GO for the following:

- Reading of operating data.
- Reading of warning and alarm indications.
- Setting of control mode.
- Setting of setpoint.
- Selection of external setpoint signal.
- Allocation of pump number to distinguish between pumps that are connected via GENIbus.
- Selection of function for digital input.
- Generation of reports in PDF.
- Assist function.
- Application Wizard menu
- Multipump setup.
- Display of relevant documentation.

For function and connection to the pump, see separate installation and operating instructions for the desired type of Grundfos GO setup.

### 12.2 Communication interface module, CIM

The pump can communicate via the wireless GENIair connection or a communication module.

This enables the pump to communicate with other pumps and with different types of network solutions.

The Grundfos communication interface modules enable the pump to connect to standard fieldbus networks.

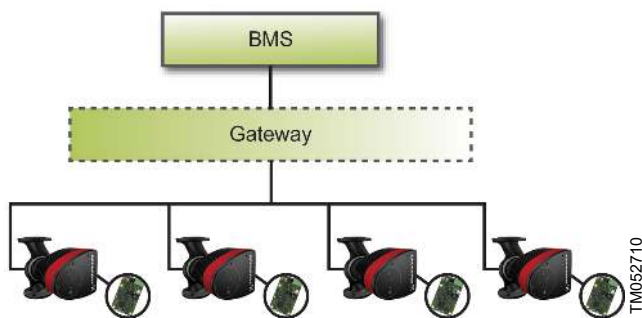

*Building management system, BMS, with four pumps connected in parallel*

A communication interface module is an add-on communication interface module.

The communication interface module enables data transmission between the pump and an external system, for example a building management system or SCADA system.

The communication interface module communicates via fieldbus protocols.



A gateway is a device that facilitates the transfer of data between two different networks based on different communication protocols.

The following communication interface modules are available:

Module	Fieldbus protocol	Product number
CIM 050	GENIbus	96824631
CIM 100	LonWorks	96824797
CIM 110	LonWorks for Twinpump	96824798
CIM 150	PROFIBUS DP	96824793
CIM 200	Modbus RTU	96824796
CIM 260-EU*	EU 3G/4G cellular	99439302
CIM 280-EU GIC GEN2*	Cellular GiC	99895383
CIM 280-US GIC GEN2*	Cellular GiC	99895386
CIM 300	BACnet MS/TP	96893770
CIM 500	Ethernet	98301408
CIM 550 Ethernet GIC	GiC	92546689

\* CIM 260-EU & CIM 280-EU GiC GEN2 is for Europe only.





\* CIM 280-US GIC GEN2 is for USA/Canada only.







Use booster functional profiles for twin-head pumps.

For further information about data communication via CIM modules, see the CIM documentation available in Grundfos Product Center.

## 12.2.1 Description of communication interface modules

Module	Fieldbus protocol	Description	Functions
CIM 050			
	GENIbus	CIM 050 is a Grundfos communication interface module used for communication with a GENIbus network.	CIM 050 has terminals for the GENIbus connection.
CIM 100			
	LonWorks	CIM 100 is a Grundfos communication interface module used for communication with a LonWorks network.	CIM 100 has terminals for the LonWorks connection. Two LEDs are used to indicate the actual status of the CIM 100 communication. One LED is used for indication of correct connection to the pump, and the other is used to indicate LonWorks communication status.
CIM 110			
	LONworks for Twinpump	CIM 110 is a Grundfos communication interface module for communication with a LON network to be used in master head of a Twinpump.	CIM 110 has FTT-10 terminals for the LonWorks connection. Two LEDs are used to indicate the actual status of the CIM 100 communication. One LED is used for indication of correct connection to the pump, and the other is used to indicate LonWorks communication status.
CIM 150			
	PROFIBUS DP	CIM 150 is a Grundfos communication interface module used for communication with a PROFIBUS network.	CIM 150 has terminals for the PROFIBUS DP connection. DIP switches are used to set line termination. Two hexadecimal rotary switches are used to set the PROFIBUS DP address. Two LEDs are used to indicate the actual status of the CIM 150 communication. One LED is used for indication of correct connection to the pump, and the other is used to indicate PROFIBUS communication status.

Module	Fieldbus protocol	Description	Functions
CIM 200	Modbus RTU	CIM 200 is a Grundfos communication interface module used for communication with a Modbus RTU network.	<p>CIM 200 has terminals for the Modbus connection.</p> <p>DIP switches are used to select parity and stop bits, to select transmission speed and to set line termination.</p> <p>Two hexadecimal rotary switches are used to set the Modbus address.</p> <p>Two LEDs are used to indicate the actual status of the CIM 200 communication.</p> <p>One LED is used for indication of correct connection to the pump, and the other is used to indicate Modbus communication status.</p>
 TM067281			
CIM 260-EU	EU 3G/4G cellular	CIM 260 is a Grundfos communication interface module, which communicates using Modbus TCP via cellular data transmission to a SCADA system or SMS communication to mobile phones. CIM 260-EU is for Europe only	<p>CIM 260 has a SIM-card slot and an SMA connection to the cellular antenna.</p> <p>CIM 260 can be fitted with a lithium-ion battery.</p> <p>Two LEDs are used to indicate the actual status of the CIM 260 communication. One LED is used for indication of correct connection to the pump, and the other is used to indicate cellular communication status.</p> <p><b>Note:</b> The SIM card is not supplied with the CIM 260.</p>
 CIM_260_280			
CIM 280-EU GIC GEN2	Cellular GIC	CIM 280-EU GIC GEN2 is a Grundfos communication interface for communication via cellular network to Grundfos iSolution Could applications. CIM 280-EU GIC GEN2 is for Europe only	<p>CIM 280-EU GIC GEN2 has a SIM-card slot and an SMA connection for a cellular antenna.</p> <p>CIM 280-EU GIC GEN2 can be fitted with a lithium-ion battery.</p> <p>Two LEDs are used to indicate the actual status of the CIM 280-EU GIC GEN2 communication. One LED is used for indication of correct connection to the pump, and the other is used to indicate cellular communication status.</p> <p><b>Note:</b> A eUICC SIM card is supplied with the CIM 280. Reach out to Grundfos to verify if your Grundfos iSolution Could application is supported. Require a related 3G/4G antenna</p>
 TM084170			
CIM 280-US GIC GEN2	Cellular GIC	CIM 280-US GIC GEN2 is a Grundfos communication interface for communication via cellular network to Grundfos iSolution Could applications. CIM 280-US GIC GEN2 is for North America/Canada only.	<p>CIM 280-US GIC GEN2 has a SIM-card slot and an SMA connection for a cellular antenna.</p> <p>CIM 280-US GIC GEN2 can be fitted with a lithium-ion battery.</p> <p>Two LEDs are used to indicate the actual status of the CIM 280-EU GIC GEN2 communication. One LED is used for indication of correct connection to the pump, and the other is used to indicate cellular communication status.</p> <p><b>Note:</b> A eUICC SIM card is supplied with the CIM 280. Reach out to Grundfos to verify if your Grundfos iSolution Could application is supported and your country fit due to frequency bands and approvals. Require a related 3G/4G antenna.</p>
 TM084170			

Module	Fieldbus protocol	Description	Functions
CIM 300	BACnet MS/TP	CIM 300 is a Grundfos communication interface module used for communication with a BACnet MS/TP network.	<p>CIM 300 has terminals for the BACnet MS/TP connection.</p> <p>DIP switches are used to set transmission speed and line termination and to select the custom Device Object Instance Number.</p> <p>Two hexadecimal rotary switches are used to set the BACnet address.</p> <p>Two LEDs are used to indicate the actual status of the CIM 300 communication.</p> <p>One LED is used for indication of correct connection to the pump, and the other is used to indicate BACnet communication status.</p>
CIM 500	Ethernet	<p>CIM 500 is a Grundfos communication interface module used for data transmission between an industrial Ethernet network and a Grundfos product.</p> <p>CIM 500 supports various industrial Ethernet protocols:</p> <p>PROFINET</p> <p>Modbus TCP</p> <p>BACnet IP</p> <p>EtherNet/IP</p>	<p>CIM 500 supports various industrial Ethernet protocols. CIM 500 is configured via the built-in web server, using a standard web browser on a PC.</p>
CIM 550	Ethernet GiC	CIM 550 Ethernet GiC interface is a Grundfos communication interface for communication via LAN and internet to Grundfos iSolution Cloud applications.	<p>CIM 550 Ethernet GiC has a RJ 45 interface for LAN connection, a RS 485 port for future Modbus RTU slave connection and a BLE radio for commissioning via Grundfos GO.</p> <p>LEDs are used to indicate the actual status of the CIM 550 communication. One LED is used for indication of correct connection to the pump, and the other is used to indicate LAN connection to Grundfos iSolution Cloud applications.</p> <p>Reach out to Grundfos to verify if your Grundfos iSolution Cloud application is supported and your country fit due to approvals.</p>

## 12.2.2 Installing a communication interface module

### WARNING

#### Electric shock

Death or serious personal injury

- Make sure that other pumps or sources do not force flow through the pump even if the pump is stopped. This will cause the motor to act like a generator, resulting in voltage on the pump.





### WARNING

#### Electric shock

Death or serious personal injury

- Switch off the power supply for at least 3 minutes before you start any work on the product. Make sure that the power supply cannot be accidentally switched on.
- It must be possible to lock the main disconnect switch to the Off position. Type and requirements as specified in national, state, and local regulations.

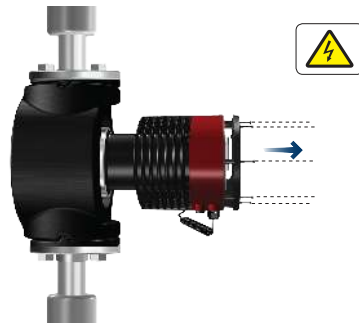
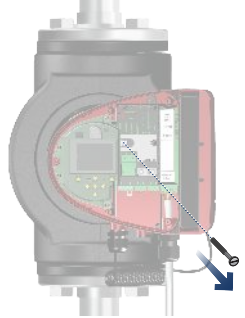
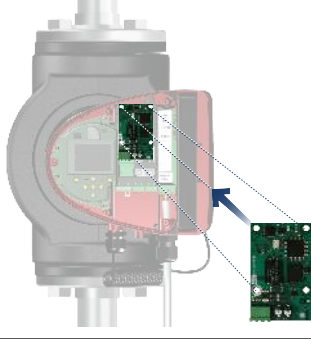
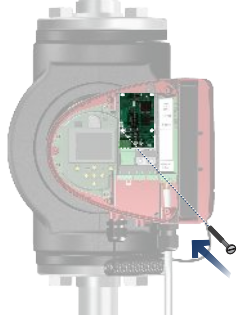

Step	Action	Illustration
1	Remove the front cover from the control box.	
2	Unscrew the ground connection.	
3	Fit the communication interface module as illustrated and click it on.	
4	Tighten the screw holding the communication interface module and secure the ground connection.	
5	For connection to fieldbus networks, see the installation and operating instructions for the desired communication interface module.	

TM052875

TM066907

TM052914

TM052912

TM052913

### 12.2.3 Reuse of communication interface modules

You can reuse a communication interface module in a CIU unit used together with Grundfos MAGNA Series 2000 in MAGNA3. Before you use the CIM module in the pump, reconfigure the module. Contact your nearest Grundfos company.

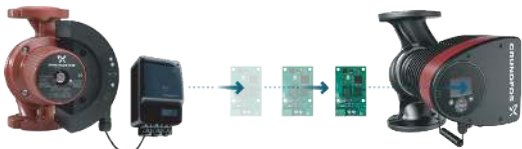

TM080517

Reuse of communication interface module

### 12.2.4 Auto detection of CIM modules

If a pump in a system with multiple pumps is replaced with a newer version model (from model D), the new pump automatically detects if the existing pump(s) and/or BMS system are older and adjusts itself accordingly.

Auto detection in twin-head pumps happens if one of the pumps is replaced and paired with a newer model than the existing one, i.e. MAGNA3 from Model D. The new pump automatically detects the model version of the existing pump. If the old pump is an older model, the new pump will adjust itself making it compatible with the old system.

Auto detection can be manually overruled if the system is controlled by a SCADA system. However, when integrating a newer model with an older setup, we recommend that you choose compatibility mode.

For more information on how to manage auto detection directly on the pump, see section "Bus communication".

#### Related information

- [TOPIC NOT IN MAP (empty topicRef)]

[href=task-xzjURgc.dita](#)

- [TOPIC NOT IN MAP (empty topicRef)]

[href=task-xzjURgc.dita](#)

[9.7.10 "Bus communication"](#)

### 12.2.5 Grundfos Remote Management

Grundfos Remote Management is an easy-to-install, low-cost solution for wireless monitoring and management of Grundfos products. It is based on a centrally hosted database and a web server with wireless data collection via GSM or GPRS modem. The system only requires an internet connection, a web browser, a Grundfos Remote Management modem and an antenna as well as a contract with Grundfos allowing you to monitor and manage Grundfos pump systems.

You have wireless access to your account anywhere and anytime you have an internet connection, for example via a mobile device. Warnings and alarms can be sent by e-mail or SMS to your mobile device.

Application	Description	Product number
CIM 280	Grundfos Remote Management Requires a contract with Grundfos and a SIM card.	99439724
GSM antenna for roof-mounting	Antenna for use on top of metal cabinets. Vandal-proof. 2-metre cable. Quad band for global use.	97631956
GSM antenna for desk-mounting	Antenna for general-purpose application, for example inside plastic cabinets. To be fixed with the double-adhesive tape supplied. 4-metre cable. Quad band for global use.	97631957

For Grundfos Remote Management contract, contact your local Grundfos company.

### 12.3 Pipe connections

Adapters for flanges are available as accessories, making it possible to install the pump in any pipe. See data booklet for *MAGNA3*, Accessories section, for the right dimension and product number.

## 12.4 External sensors

### 12.4.1 Temperature sensor

Sensor	Type	Measuring range [psi (bar)]	Measuring range [°F (°C)]	Transmitter output [VDC]	Power supply [VDC]	Process connection	Product number
Combined pressure and temperature sensor	RPI T2	0-232 (0-16)	14 to 248 (-10 to +120)	2 x 0-10 4 wire	16.6 - 30	G 1/2	98355521

### 12.4.2 Pressure sensor

Sensor	Type	Measuring range [psi]	Measuring range [bar]	Transmitter output [mA]	Power supply [VDC]	Process connection	Product number
Pressure transmitter	RPI	0-9	(0 - 0.6)	4 to 20	12 to 30	G 1/2	97748907
		0-15	(0 - 1.0)				97748908
		0-25	(0 - 1.6)				97748909
		0-35	(0 - 2.5)				97748910

## 12.5 Adapter

Adapter	Product number
Adapter for 1/4" NPT	98344015

## 12.6 Cable for sensors

Description	Length [ft (m)]	Product number
Screened cable	6.56 (2.0)	98374260
Screened cable	16.40 (5.0)	98374271

## 12.7 Blanking flange

The accessory is used to blank off the opening when one of the pump heads of a twin-head pump is removed for service to enable uninterrupted operation of the other pump.

The accessory set consists of a blanking flange and a fastener set.

Pump type	Product number
MAGNA3 D 65-150 F	98159372
MAGNA3 D 80-100 F	
MAGNA3 D 100-120 F	

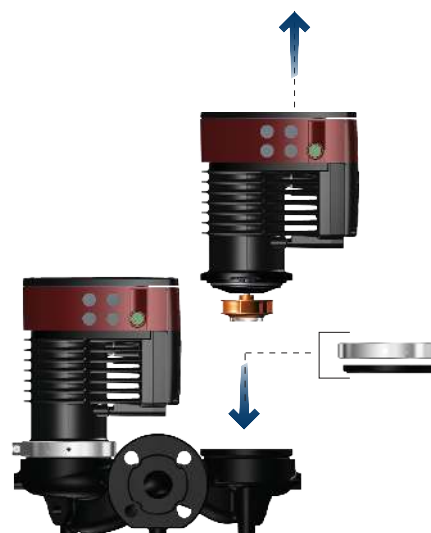

Position of a blanking flange

TM068518

## 12.8 Insulating kits for applications with ice buildup

The accessory is for single-head MAGNA pumps used in applications with ice buildup.

The accessory set consists of two polyurethane (PUR) shells and metal clamps to ensure tight assembly.

The dimensions of the insulating shells for air-conditioning and cooling systems differ from those of the insulating shells for heating systems. You can use the insulating shells for both stainless-steel and cast-iron pumps.

Pump type	Product number
MAGNA3 25-40/60/80/100/120 (N)	98354534
MAGNA3 32-40/60/80/100/120 (N)	98354535
MAGNA3 32-40/60/80/100 F (N)	98354536
MAGNA3 32-120 F (N)	98063287
MAGNA3 40-40/60 F (N)	98354537
MAGNA3 40-80/100 F (N)	98063288
MAGNA3 40-120/150/180 F (N)	98145675
MAGNA3 50-40/60/80 F (N)	98063289
MAGNA3 50-100/120/150/180 F (N)	98145676
MAGNA3 65-40/60/80/100/120 F (N)	96913593
MAGNA3 65-150 F (N)*	99608813
MAGNA3 80-40/60/80/100/120 F*	98134265*
MAGNA3 100-40/60/80/100/120 F*	96913589

\* If the control box of the pump is turned, the insulating shells are not applicable. Contact Grundfos for assistance.

Not all variants are available in all markets.

Specifications:

- Specific volume resistance greater than or equal to  $10^{15}$   $\Omega$ cm, DIN 60093
- thermal conductivity at 10 °C 0.036 W/mK and at 40 °C 0.039 W/mK, DIN 52612
- density  $33 \pm 5$  kg/m<sup>3</sup>, ISO 845
- working temperature range -40 to +90 °C, ISO 2796.

## 13. Technical data

### Supply voltage

1 x 115-230 V  $\pm$  10 %, 50/60 Hz, PE. Check that the supply voltage and frequency correspond to the values stated on the nameplate.

### Motor protection

The pump requires no external motor protection.

### Enclosure class

Type 2.

### Insulation class

F.

### Relative humidity

Maximum 95 %.

### Ambient temperature

32 to 104 °F (0 to +40 °C).

Ambient temperatures below 32 °F (0 °C) require the following conditions:



- The media temperature is 41 °F (5 °C).
- The media contains glycol.
- The pump runs continuously and does not stop.
- For twin-head pumps cascade operation every 24 hours is mandatory.

Ambient temperature during transport: -40 to 158 °F (-40 to +70 °C).

In cooling applications condensation may occur on the surface of the pump.

Condensating application allowed only if the power is on.

### Liquid temperature

Continuously: +14 to +230 °F (-10 to +110 °C).

Stainless-steel pumps in domestic hot-water systems:

In domestic hot-water systems, we recommend that you keep the liquid temperature below 149 °F (65 °C) to eliminate the risk of lime precipitation.

### System pressure



The actual inlet pressure and the pump pressure against a closed valve must be lower than the maximum permissible system pressure.

The maximum permissible system pressure is stated on the pump nameplate:

PN 6: 87 psi (6 bar / 0.6 MPa)

PN 10: 145 (10 bar / 1.0 MPa)

PN 12: 175 psi (12 bar / 1.2 MPa)

PN 16: 232 (16 bar / 1.6 MPa).

Not all variants are available in all markets.

### Test pressure

The pumps can withstand test pressures as indicated in EN 60335-2-51. See below.

- PN 6: 104.4 psi (7.2 bar / 0.72 MPa)
- PN 10: 175 psi (12 bar / 1.2 MPa)
- PN 6/10: 175 psi (12 bar / 1.2 MPa)
- PN 12: 175 psi (12 bar / 1.2 MPa)
- PN 16: 278.5 psi (19.2 bar / 1.92 MPa).

Not all variants are available in all markets.

During normal operation, do not use the pump at higher pressures than those stated on the nameplate.

The pressure test has been made with water containing anticorrosive additives at a temperature of 68 °F (20 °C).

### Minimum inlet pressure

The following relative minimum inlet pressure must be available at the pump inlet during operation to avoid cavitation noise and damage to the pump bearings.



The values in the table below apply to single-head pumps and twin-head pumps in single-head operation. Not all variants are available in all markets.

MAGNA3	Liquid temperature			
	77 °F (25 °C)	167 °F (75 °C)	203 °F (95 °C)	230 °F (110 °C)
	Inlet pressure [psi (bar)]			
25-40/60/80/100/120	32 (0.0)	1.5 (0.10)	5 (0.35)	14.5 (1.0)
32-40/60/80/100/120	32 (0.0)	1.5 (0.10)	5 (0.35)	14.5 (1.0)
32-40/60/80/100/120 F	32 (0.0)	1.5 (0.10)	5 (0.35)	14.5 (1.0)
32-120 F	32 (0.0)	1.5 (0.10)	2.9 (0.2)	10.15 (0.7)
40-40/60 F	32 (0.0)	1.5 (0.10)	5 (0.35)	14.5 (1)
40-80/100/120/150/1 80 F	32 (0.0)	1.5 (0.10)	7.25 (0.5)	14.5 (1)
50-40/60/80 F	32 (0.0)	1.5 (0.10)	5.8 (0.4)	14.5 (1)
50-100/120 F	32 (0.0)	1.5 (0.10)	7.25 (0.5)	14.5 (1)
50-150/180 F	32.7 (0.4)	10.15 (0.70)	17.4 (1.2)	24.66 (1.7)
65-40/60/80/100/120/ 150 F	32.7 (0.4)	10.15 (0.70)	17.4 (1.2)	24.66 (1.7)
80-40/60/80/100/120 F	32.3 (0.2)	7.25 (0.50)	14.5 (1.0)	21.76 (1.5)
100-40/60/80/100/12 0 F	32.7 (0.4)	10.15 (0.70)	17.4 (1.20)	24.66 (1.7)

In the case of cascade operation, the required relative inlet pressure must be increased by 1.45 psi (0.1 bar / 0.01 MPa) compared to the stated values for single-head pumps or twin-head pumps in single-head operation.

The relative minimum inlet pressures apply to pumps installed up to 984 ft (300 metres) above sea level. For altitudes above 984 ft (300 metres), the required relative inlet pressure must be increased by 0.145 psi (0.01 bar / 0.001 MPa) per 328 ft (100 metres) altitude. The MAGNA3 pump is only approved for an altitude of 6560 ft (2000 metres) above sea level.

### Flanges and torques

The sound pressure level of the pump is dependent on the power consumption. Levels are determined in accordance with ISO 3745 and ISO 11203, method Q2.

Pump size	Max. dB(A)
25-40/60/80/100/120	
32-40/60/80/100/120	
40-40/60	39
50-40	
32-120 F	
40-80/100	
50-60/80	45
65-40/60	
80-40	
40-120/150/180	
50-100/120/150/180	
65-80/100/120	50
80-60/80	
100-40/60	
65-150	
80-100/120	55
100-80/100/120	

### Leakage current

The mains filter will cause a leakage current to earth during operation. The leakage current is less than 3.5 mA.

### Consumption when the pump is stopped

4 to 10 W, depending on activity, such as reading the display, use of Grundfos GO, interaction with modules.

4 W when the pump is stopped and there is no activity.

### Input and output communication

	External potential-free contact.
Two digital inputs	Contact load: 5 V, 10 mA.
	Screened cable.
	Loop resistance: Maximum 130 Ω.
Analog input	4-20 mA, load: 150 Ω.
	0-10 VDC, load: Greater than 10 kΩ.
Two relay outputs	Internal potential-free changeover contact.
	Maximum load: 250 V, 2 A, AC1.
	Minimum load: 5 VDC, 20 mA.
	Screened cable, depending on signal level.
24 VDC supply	Maximum load: 22 mA.
	Capacitive load: Less than 470 µF.

### Cable glands

Use M16 cable glands for the input and output connections (not supplied with the pump).

### Power factor

The terminal-connected versions have built-in an active power factor correction which gives a  $\cos \phi$  from 0.98 to 0.99.



## 13.1 Sensor specifications

### 13.1.1 Temperature

Temperature range during operation	Accuracy
+14 to +95 °F (-10 to +35 °C)	± 4 °F (± 2 °C)
+95 to +194 °F (+35 to +90 °C)	± 2 °F (± 1 °C)
+194 to +230 °F (+90 to +110 °C)	± 4 °F (± 2 °C)

### 13.2 Markings and approvals

The following marks are available after positive testing of MAGNA3:

Mark	Description
Listed	Intertek - ETL Listed for USA and Canada
 Intertek	Conforms to ANSI/UL Std. 778 Motor Operated Water Pumps
	Certified to CAN/CSA C22.2 No. 108 Liquid Pumps
 NSF/ANSI 372	USA and Canada Applies to pumps with stainless steel pump housing (flange).

### 14. Disposing of the product

This product has been designed with focus on the disposal and recycling of materials. The following average disposal values apply to all variants of pumps:

- 85 % recycling
- 10 % incineration
- 5 % depositing.

This product or parts of it must be disposed of in an environmentally sound way:

1. Use the public or private waste collection service.
2. If this is not possible, contact the nearest Grundfos company or service workshop.

See also end-of-life information at [www.grundfos.com/product-recycling](http://www.grundfos.com/product-recycling).

#### WARNING

##### Magnetic field

Death or serious personal injury



- Persons with pacemakers disassembling this product must exercise care when handling the magnetic materials embedded in the rotor.

**U.S.A.**

Global Headquarters for WU  
856 Koomey Road  
Brookshire, Texas 77423 USA  
Phone: +1-630-236-5500

GRUNDFOS CBS Inc.  
902 Koomey Road  
Brookshire, TX 77423 USA  
Phone: 281-994-2700  
Toll Free: 1-800-955-5847  
Fax: 1-800-945-4777

GRUNDFOS Pumps Corporation  
9300 Loiret Boulevard  
Lenexa, Kansas 66219 USA  
Tel.: +1 913 227 3400  
Fax: +1 913 227 3500

**Canada**

GRUNDFOS Canada inc.  
2941 Brighton Road  
Oakville, Ontario  
L6H 6C9  
Tel.: +1-905 829 9533  
Fax: +1-905 829 9512

**Mexico**

Bombas GRUNDFOS de México  
S.A. de C.V.  
Boulevard TLC No. 15  
Parque industrial Stiva Aeropuerto  
Apodaca, N.L. 66600  
Tel.: +52-81-8144 4000  
Fax: +52-81-8144 4010

**Revision Info**

Last revised on 04-2021

<b>99332342</b> 102023
ECM: 1379433